

## Propel XFrame™ and Front Access Panels

### Contents

Introduction.....	2
Related Publications.....	2
1 Product Description.....	2
1.1 General Description.....	2
1.2 Products Covered by This User Manual.....	3
1.3 Compatible Products.....	3
2 Propel XFrame.....	4
2.1 Frame Dimensions and Specifications.....	4
2.2 Required Tools and Materials.....	6
2.3 Frame Unpacking and Inspection.....	6
2.4 Frame Assembly and Installation.....	7
2.5 Frame Configurations.....	9
2.6 Frame Accessories.....	10
3 Propel Front Access Panels.....	13
3.1 Panel Dimensions and Specifications.....	13
3.2 Panel Unpacking and Inspection.....	15
3.3 Panel Installation on Frame.....	16
4 Operational Details.....	18
4.1 Propel Front Access Panels Operation.....	18
4.2 Propel XFrame with Panels Operation.....	20
4.3 General Best Practices.....	20
4.4 HCM Panels Best Practices.....	22
4.5 VCM Panels Best Practices.....	23
4.6 HCM Patch Cord Routing Diagrams.....	24
4.7 VCM Patch Cord Routing Diagrams.....	25
4.8 Stand-Alone Frame Routing Diagram.....	26
5 Contact Information.....	27

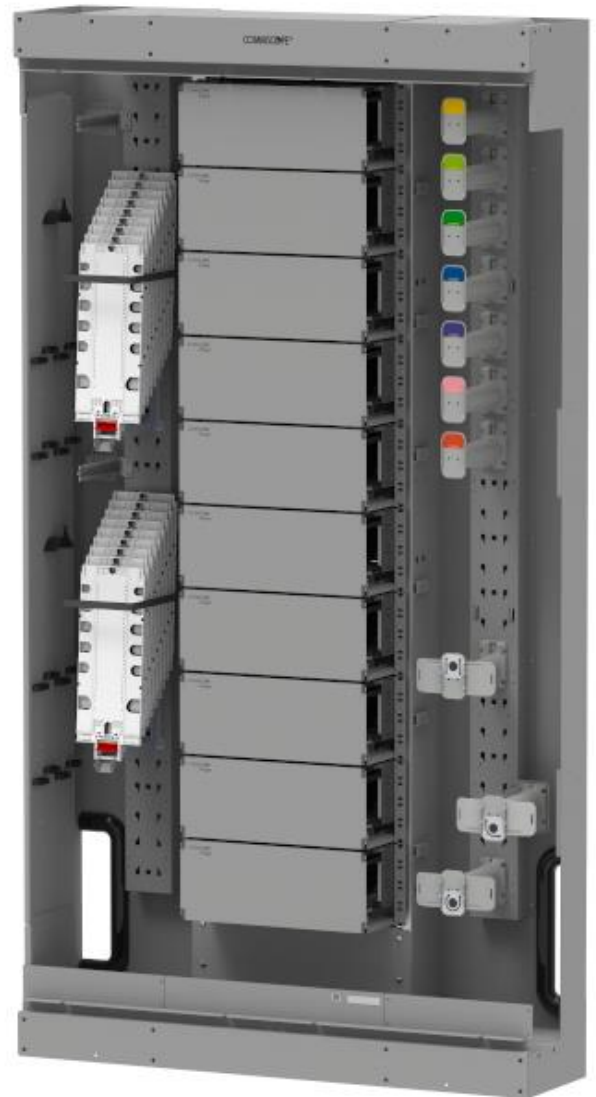

## Introduction

This user manual describes the Propel XFrame and Front Access Panels and provides directions for installation.

Procedures include: unpacking products, assembling and mounting the frame, configuring cable management features, installing and operating panels, routing fiber cables, and deploying product accessories.

The document also lists related publications and tells how to obtain technical assistance.

## Related Publications

The following related publications are shipped with the product and are available for download at <https://www.commscope.com/SupportCenter>

- **Propel XFrame Installation Drawing (6601063115)** -- provides instructions for assembling and installing the Propel XFrame
- **Propel XFrame Quick Start Guide (TC-01001516-IP)** -- provides guidelines for unpacking, assembling, and using the Propel XFrame with Propel Front Access Panels and Propel fiber connection components (sold separately)
- **Propel Front Access HCM Panels Quick Start Guide (TC-01001512-IP)** -- provides guidelines for unpacking, mounting, and using Propel Front Access Panels with features supporting Horizontal Cable Management
- **Propel Front Access VCM Panels Quick Start Guide (TC-01001513-IP)** -- provides guidelines for unpacking, mounting, and using Propel Front Access Panels with features supporting Vertical Cable Management

## 1 Product Description

### 1.1 General Description

Propel XFrame products offer a flexible, efficient fiber optic management solution for high-density data center environments. Designed for simplicity and compatibility with CommScope's Propel platform, the system enhances spatial optimization and supports rapid deployment of modern fiber optic architectures.

The Propel XFrame is an optical distribution frame providing a connection point between facility cables. The basic product consists of a 19-inch rack with two cable managers, one on each side.

The Propel Front Access Panels are 19-inch rack mounted fiber patch panels, available in 3RU, 4RU and 5RU heights. Panels utilize standard Propel connection components, and support one of two cable management methods, horizontal (HCM) or vertical (VCM).

## 1.2 Products Covered by This User Manual

[Table 1](#) lists the Propel XFrame products covered in this user manual.

**Table 1. Propel XFrame Products**

Material ID (MID)	Catalog #	Description
760258349	PPL-FRAME-KT-WDRS	Propel XFrame with Doors
760258350	PPL-FRAME-KT	Propel XFrame without Doors
760258348	PPL-FRAME-SPLC-KT	Propel XFrame Splicing Kit
760258367	PPL-FRAME-SDPNL-KT	Propel XFrame Side Panel Kit
760258368	PPL-FRAME-TROUGH-KT	Propel XFrame Top Trough Kit
760258354	PPL-FA-3U-HCM	Propel Front Access Panel, 3RU, Horizontal Cable Management
760258356	PPL-FA-4U-HCM	Propel Front Access Panel, 4RU, Horizontal Cable Management
760258355	PPL-FA-4U-VCM	Propel Front Access Panel, 4RU, Vertical Cable Management
760258357	PPL-FA-5U-VCM	Propel Front Access Panel, 5RU, Vertical Cable Management

## 1.3 Compatible Products

The Propel XFrame solution is compatible with 8 fiber, 12 fiber and 16 fiber Propel modules, cabled modules and splice cassettes, and also 4-port, 6-port and 8-port Propel adapter packs.

Please refer to the [Propel Ordering Guide](#) for Propel components that can be used with the Propel XFrame.

CommScope ULL cable assemblies and patch cords can be used with the Propel XFrame. The 60" breakout is recommended for cable assemblies and 5 meter length is recommended for patch cords in most configurations (see [Section 4.3](#) for details).

## 2 Propel XFrame

### 2.1 Frame Dimensions and Specifications

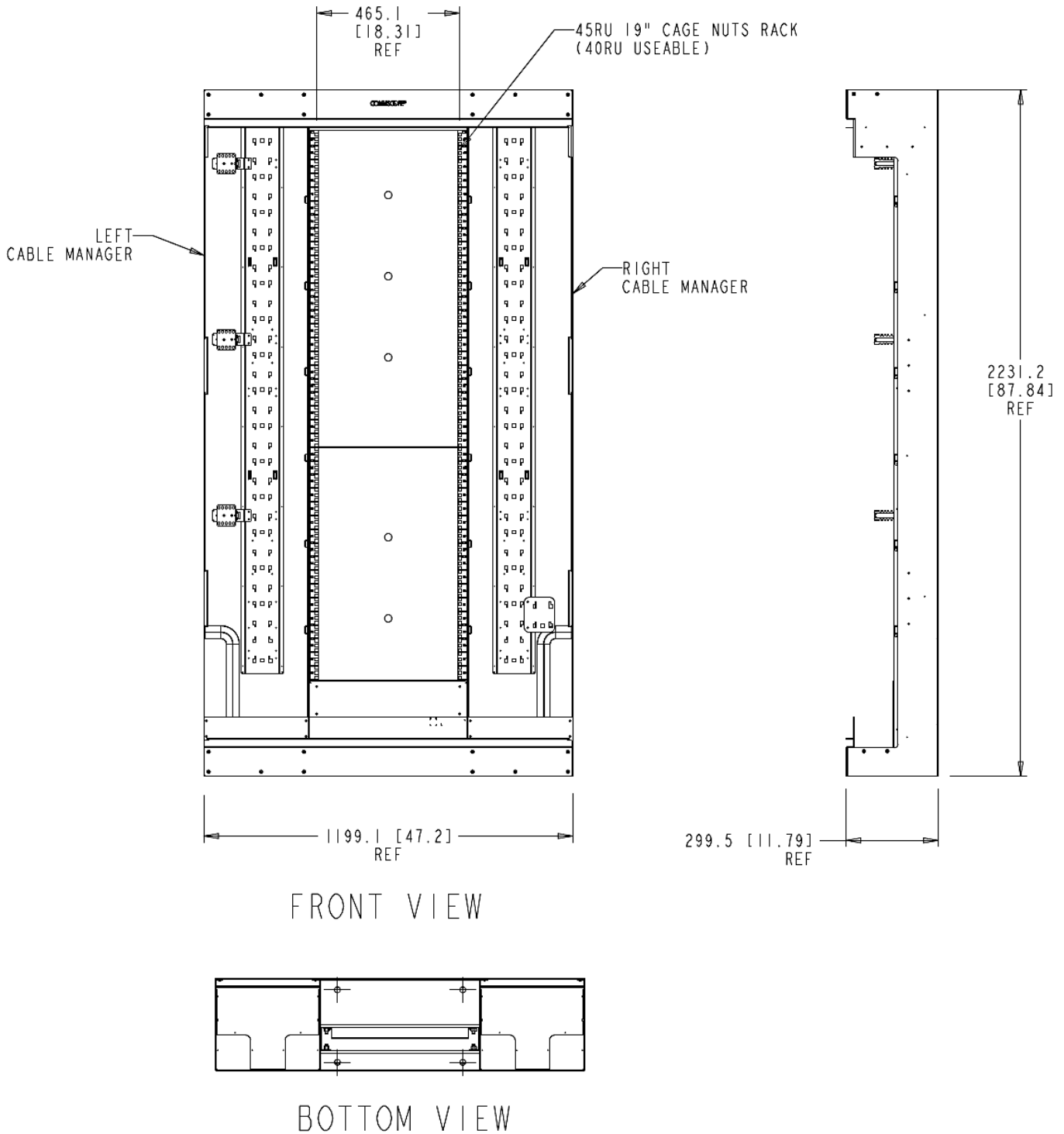

**Figure 1. Propel XFrame Dimensions**

Table 2 lists the installation specifications for the Propel XFrame.

**Table 2. Propel XFrame Specifications**

Parameter	XFrame Kit (No Doors)	XFrame Kit (With Doors)
Catalog Number	PPL-FRAME-KT	PPL-FRAME-KT-WDRS
Mounting RU	40	40
Total RU	45	45
Height	87.8 in (223.1 cm)	87.8 in (223.1 cm)
Width	47.2 in (119.9 cm)	47.2 in (119.9 cm)
Depth	11.8 in (30.0 cm)	12.0 in (30.5 cm) <i>[base footprint same as without doors]</i>
Net Weight (Product Only)	148 lbs (67 kg)	184 lbs (83 kg)
Gross Weight (With Packaging)	286 lbs (130 kg)	322 lbs (146 kg)

Table 3 lists the maximum fiber capacities of the Propel XFrame, per panel type and size.

**Table 3. Propel XFrame Maximum Densities**

Front Connector Interface	XFrame with HCM Panels		XFrame with VCM Panels	
	Panel Size	Fiber Count	Panel Size	Fiber Count
LC – 12f	3RU	3,744	4RU	2,880
SN – 24f		<i>Not Recommended</i>		5,760
MPO8 – 6-Port Adapter Packs		14,976		11,520
MPO12 – 6-Port Adapter Packs		22,464		17,280
MPO16 – 6-Port Adapter Packs		29,952		23,040
LC – 8f/16f	4RU	3,840	5RU	3,072
SN – 16f/32f		<i>Not Recommended</i>		6,144
MPO8 – 4/8-Port Adapter Packs		15,360		12,288
MPO12 – 4/8-Port Adapter Packs		23,040		18,432
MPO16 – 4/8-Port Adapter Packs		<i>Not Recommended</i>		<i>Not Recommended</i>

## 2.2 Required Tools and Materials

The following tools are required for assembling and installing the Propel XFrame.

- Slot tip and Phillips screwdrivers - #1, #2, #3
- Socket wrench with deep socket - 3/4 inch (19 mm)
- Open-end/box-end wrench - 3/4 inch (19 mm)
- Drill with 11/16 inch (18 mm) concrete drill bit
- Level or Square
- Tape measure
- Hammer
- Work gloves
- Vacuum

**NOTE:**

Depending on site requirements and installer provided mounting hardware, other tools may be needed.

## 2.3 Frame Unpacking and Inspection

The Propel XFrame is shipped inside of a banded, corrugated cardboard container on a 94" x 30" (239 cm x 76 cm) wood pallet. Use the following procedure to unpack the frame kit contents.

- a) Using a forklift, move the pallet to the installation location within your facility.
- b) Before unpacking, inspect the exterior of the shipping container for evidence of rough handling that may have damaged the components inside. If damage is detected or if parts are missing, file a claim with the commercial carrier and notify the CommScope Support Center at <http://www.commscope.com/SupportCenter>.
- c) Cut the banding straps and remove the top tray of the container.
- d) Remove the accessories box and floor mounting template, highlighted in Figure 2. The accessories box includes the Quick Start Guide (TC-01001516-IP) and Installation Drawing (6601063115), which provides step-by-step assembly instructions.
- e) Carefully unpack the remaining boxed items as needed. The packaging component numbers in Figure 2 correspond to the assembly steps of the Installation Drawing (6601063115) and Figure 3.
- f) Recycle packaging.

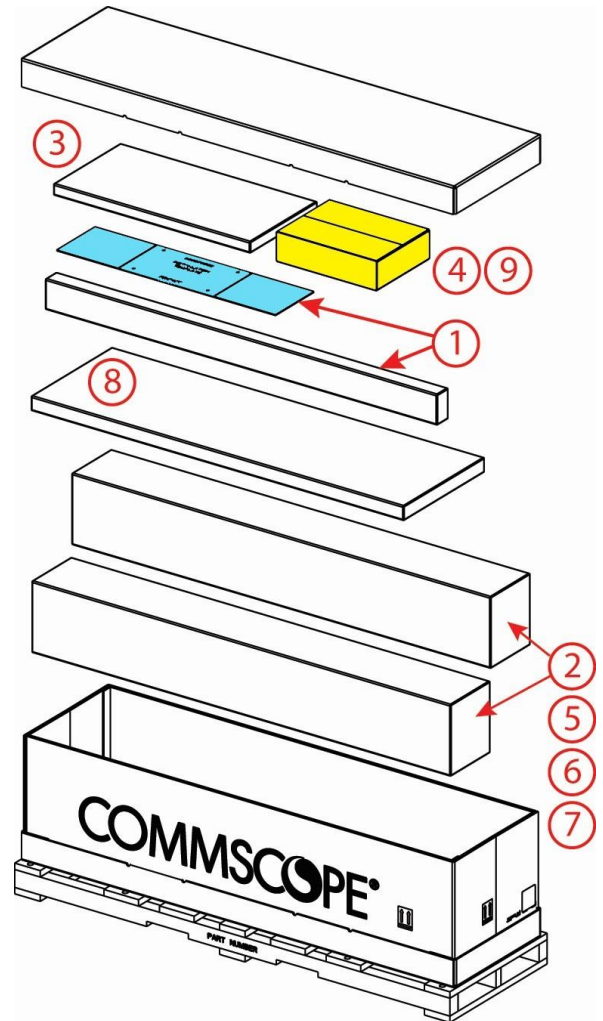
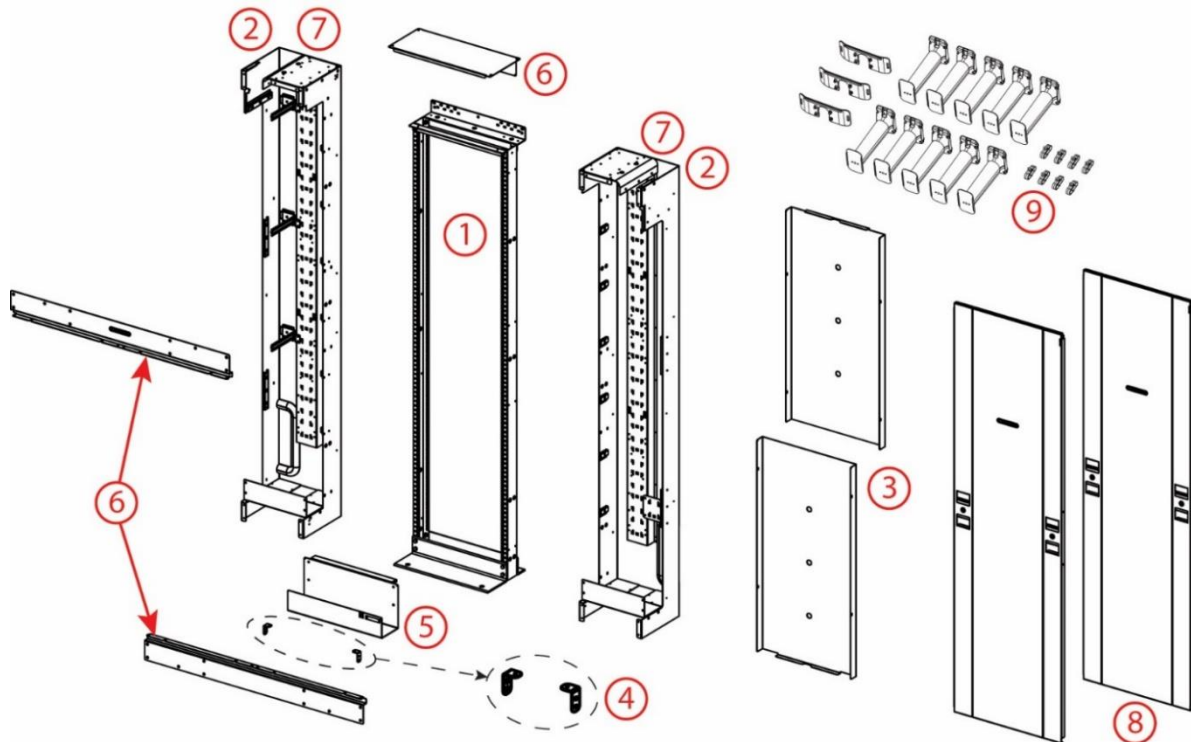

**Figure 2. Propel XFrame Unpacking**

## 2.4 Frame Assembly and Installation

Before starting the assembly process, read the Installation Drawing (6601063115) in full.

**SAFETY WARNING:** The frame will remain unstable until it is securely attached to the floor AND ceiling or wall. Provide adequate support until it is completely fastened.



**Figure 3. Propel XFrame Components**

The Propel XFrame can be installed on a concrete floor or raised floor. Installation involves the following main steps, where each step number corresponds to the numbered items in [Figure 2](#) and [Figure 3](#).

- 0) Mounting frame to floor. →
- 1) Rack assembly.
- 2) Side managers assembly.
- 3) Rear cover assembly.
- 4) Trough brackets and cage nuts assembly.
- 5) Trough assembly.
- 6) Door supports assembly.
- 7) (IF NEEDED) Side manager configuration. See [Section 2.5](#) for details.
- 8) (IF INCLUDED) Door assembly.
- 9) Spools, labels, and clips assembly.

**NOTE:**

Perform Step '0' according to your frame mounting configuration below and in [Figure 4](#).

- **Stand-Alone Mounting:** after Step 2
- **Wall Mounting:** after Step 3
- **Back-to-Back Mounting:** after Step 3

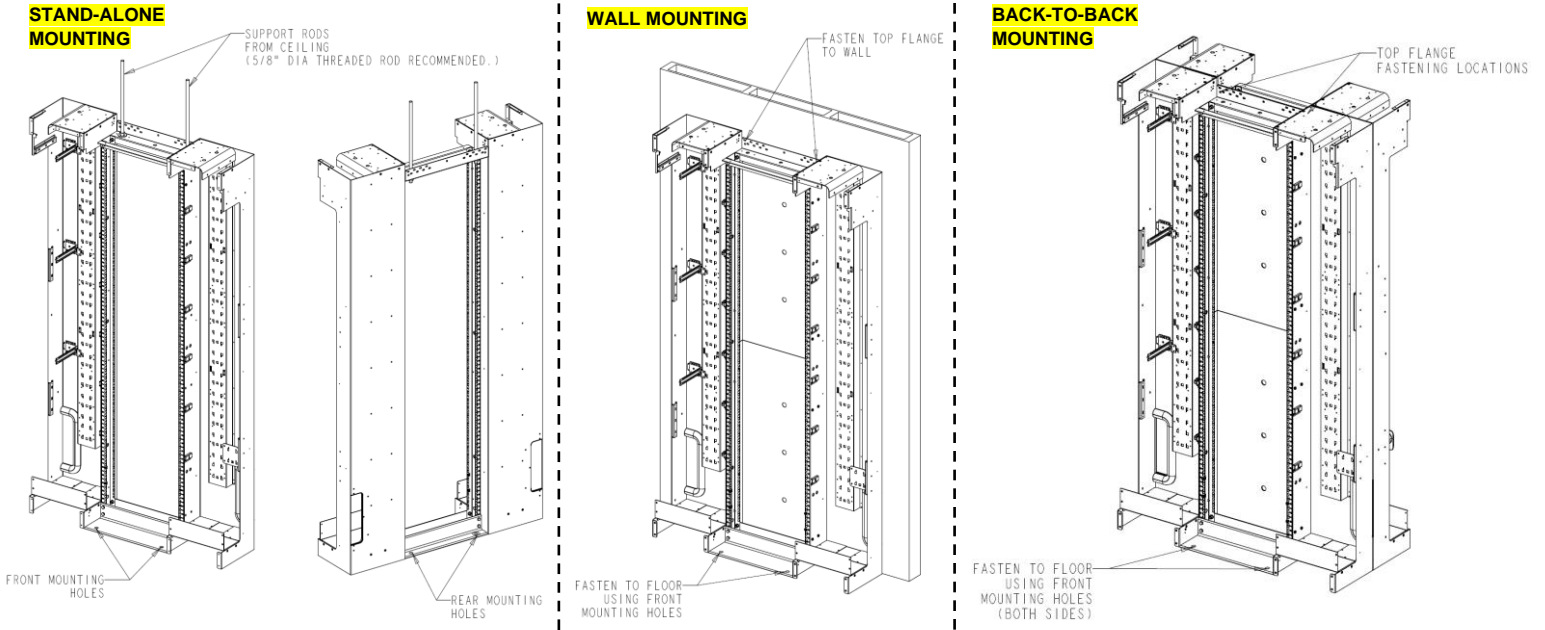

**Figure 4. Frame Mounting Configurations and Fastening Locations**

Figure 5 shows the Propel XFrame installation template with footprint dimensions and mounting hole locations. Refer to the instruction document with the anchor bolts for installation details. Drill floor holes before moving frame into place.

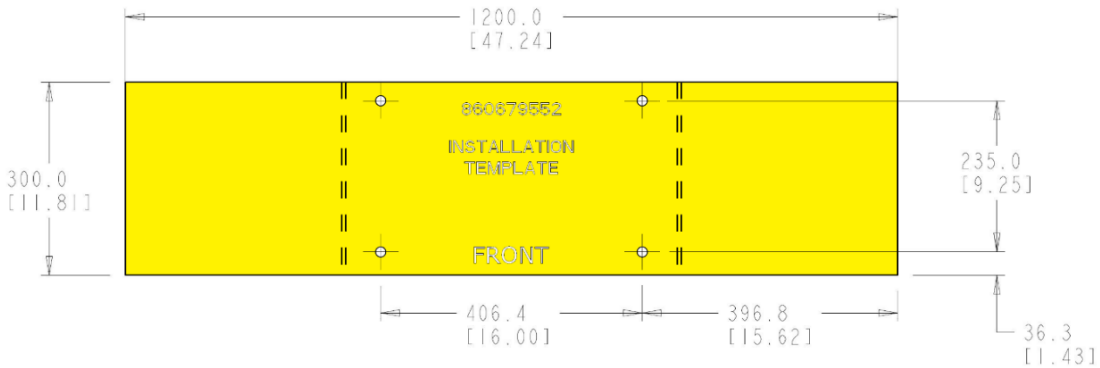

**Figure 5. Frame Footprint (Floor Installation Template)**

If required, connect the frame to earth ground per local practice. Figure 6 shows the grounding locations at the top of the rack and frame side manager.



**Figure 6.  
Frame  
Grounding  
Example**



## 2.5 Frame Configurations

The Propel XFrame is shipped with side manager brackets configured for the frame scenario on the left of [Figure 7](#) and [Figure 8](#). If a mirrored configuration is needed, move the brackets to the opposing location in the other side manager bay of the frame. See highlighted bracket and spool positions in [Figure 7](#).

Additionally, if the bottom openings of the frame need to be used for cable entry from the floor, move the top cable mounting bracket to the lowest position within the side manager.

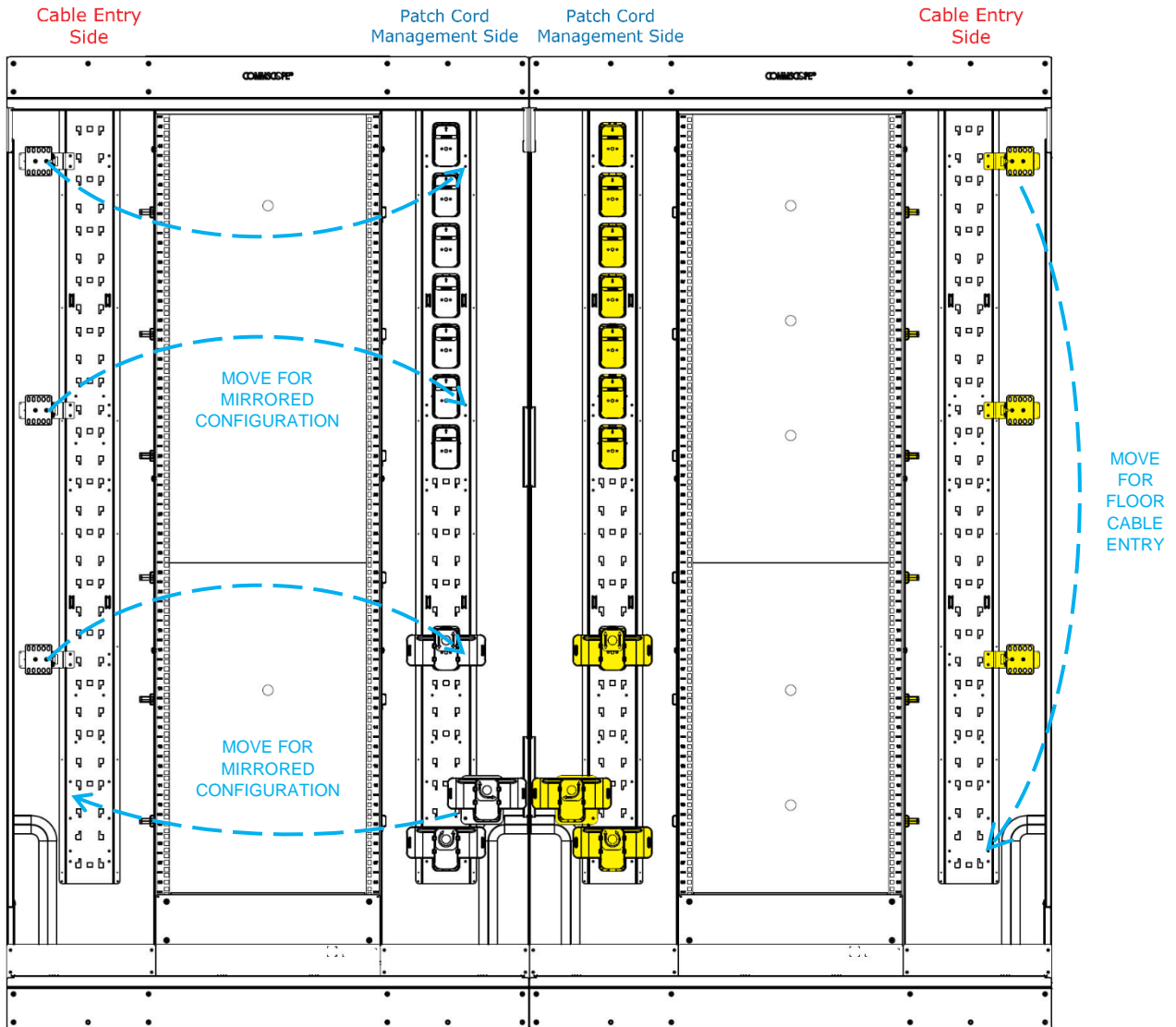

**Figure 7. Side-by-Side, Back-to-Back, or Lineup Frame Configurations**

For stand-alone frame applications, redistribute the spools as shown in [Figure 8](#), to accommodate patch cord slack within the frame. As with multi-frame scenarios, side manager brackets can be moved to the opposite side of the frame for a mirrored configuration (highlighted in [Figure 8](#)). Remove spools and cable retainers as needed.

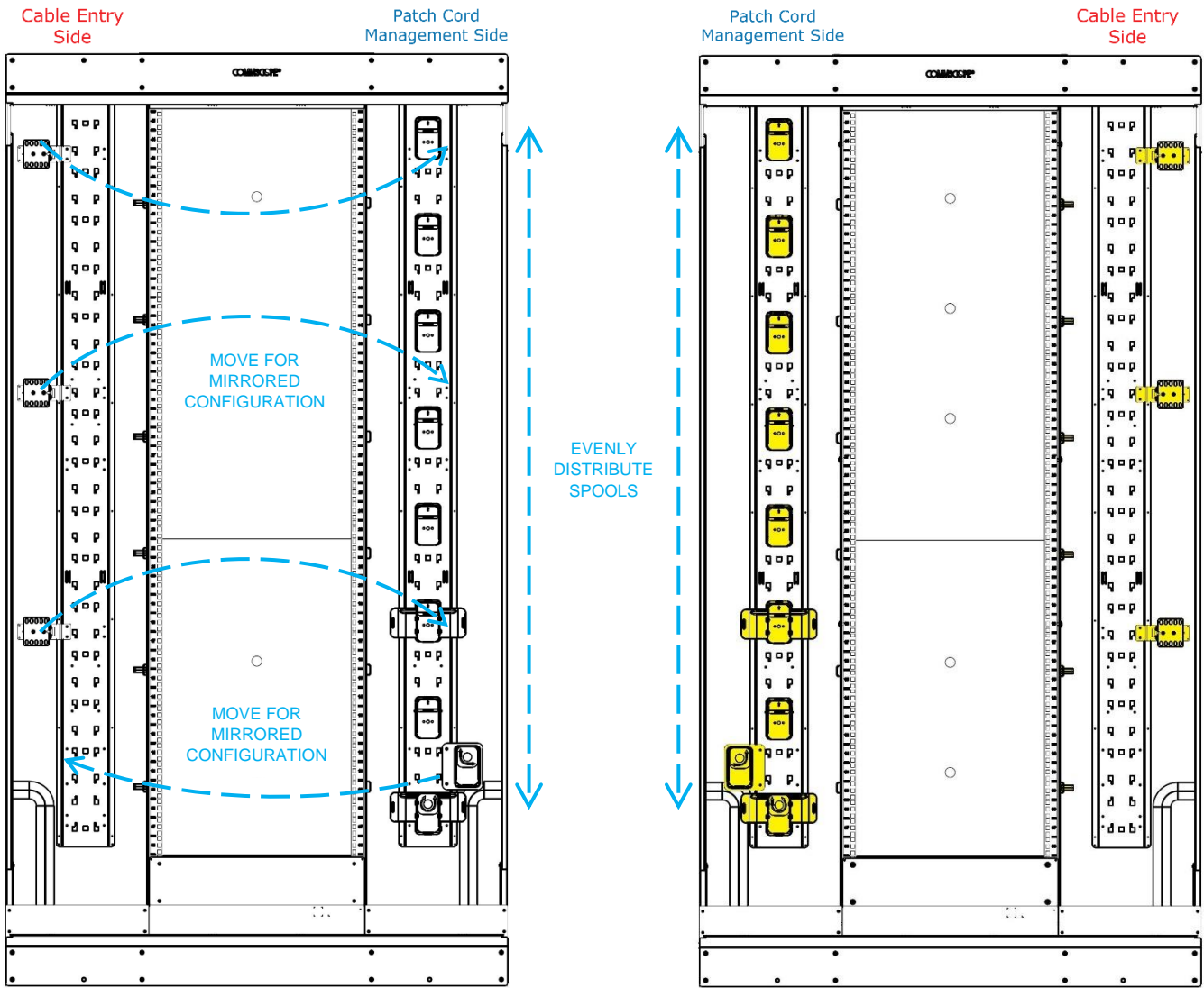

Figure 8. Stand-Alone Frame Configurations

### 2.6 Frame Accessories

The Propel XFrame is designed to accommodate accessory attachments that extend its functionalities, including the frame Side Panels, Splice kit, and Top Trough. These accessory kits are sold separately from the Propel XFrame.



Figure 9. Frame Side Panels



**Figure 10. Frame Splice Kit Contents**

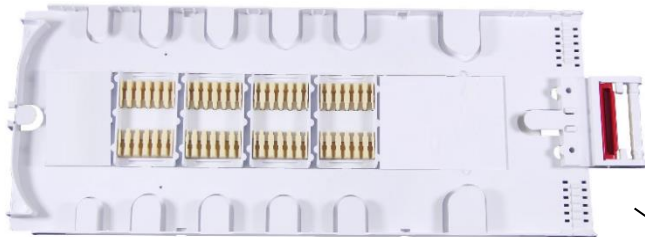

*FOST-ACC-D-TRAY-RR-288-KIT*

**Figure 11. 288-Fiber Splicing Tray**

The Side Panels kit includes two attachable metal panels, depicted in [Figure 9](#), that are used close off the ends of the XFrame side managers. One kit is typically used for each stand-alone frame or pair of frames in a lineup. The bottom plate on each side panel can be removed to allow cables to pass between adjacent frames.

The Splice kit ([Figure 10](#)) includes brackets to support up to 18 total 288-Fiber Splicing Trays ([Figure 11](#)). This approach, referred to as “on-frame splicing”, allows cable installers to leverage mass fusion splicing of trunk cables to Propel Cabled Modules for fast deployment of high fiber counts. For individual or low fiber count cables, “in-panel” splicing using Propel Splice Cassettes is recommended.

**NOTE:** A Side Panel is necessary to install the Splice Kit cable clips and radius limiters. See [Figure 12](#).

The Top Trough kit, shown in [Figure 13](#), fastens to the top of the XFrame. It provides an overhead pathway for cables to pass between side managers or frames in a lineup.

Alternatively, CommScope FiberGuide® can be installed using bracket *FGS-HCTS-A/B*.

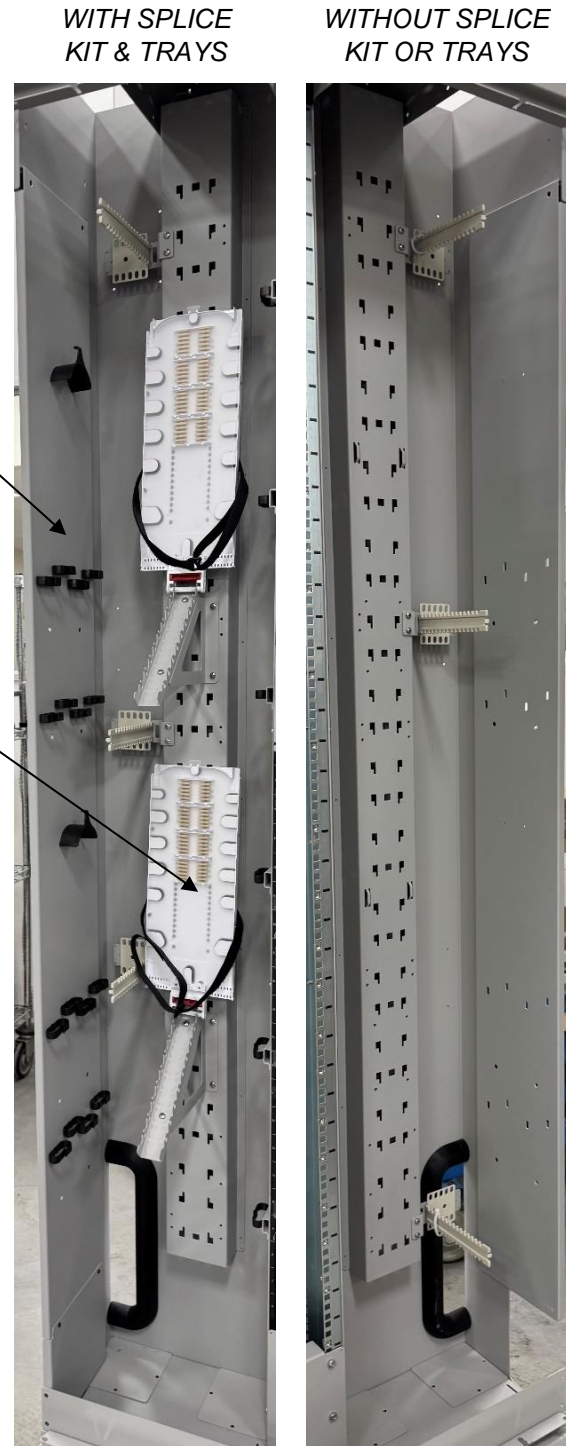

**Figure 12. Frame Side Managers with Side Panels**



**Figure 13. Frame Top Trough**

Table 4 lists the installation specifications of the Propel XFrame Accessories (sold separately).

**Table 4. Propel XFrame Accessories Specifications**

Parameter	Side Panels Kit	Splicing Kit	Top Trough Kit
Catalog Number	PPL-FRAME-SDPNL-KT	PPL-FRAME-SPLC-KT	PPL-FRAME-TROUGH-KT
Use	Closes off frame ends, Supports splice cable routing	Allows on-frame splicing of high fiber count cables	Provides cable guidance along top of frame
Packaged Height	82.1 in (208.5 cm)	8.4 in (21.3 cm)	4.5 in (11.4 cm)
Packaged Width	13.6 in (34.5 cm)	9.4 (23.9 cm)	52.8 in (134.1 cm)
Packaged Depth	3.9 in (9.9 cm)	11.4 (29.0 cm)	15.0 in (38.1 cm)
Net Weight (Product Only)	11.5 lbs (5.2 kg)	2.7 lbs (1.2 kg)	6.8 lbs (3.1 kg)
Gross Weight (With Packaging)	20.4 lbs (9.3 kg)	3.6 lbs (1.6 kg)	13.6 lbs (6.2 kg)

### 3 Propel Front Access Panels

#### 3.1 Panel Dimensions and Specifications

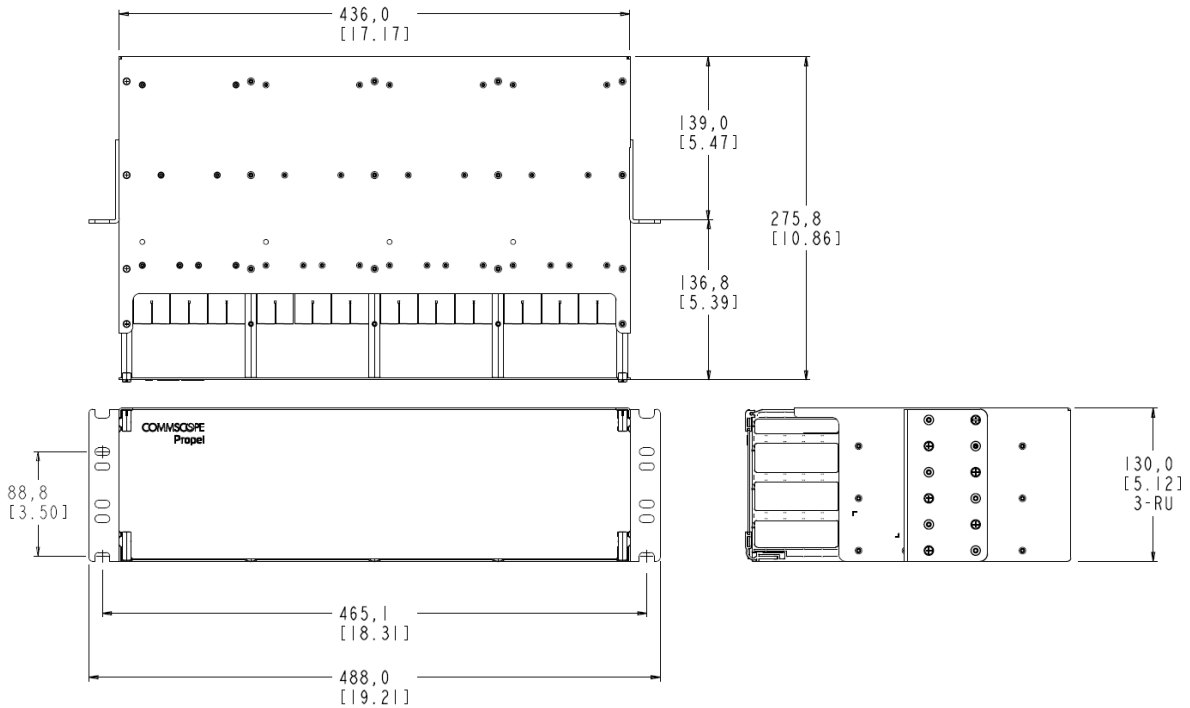

Figure 14. PPL-FA-3U-HCM Panel Dimensions

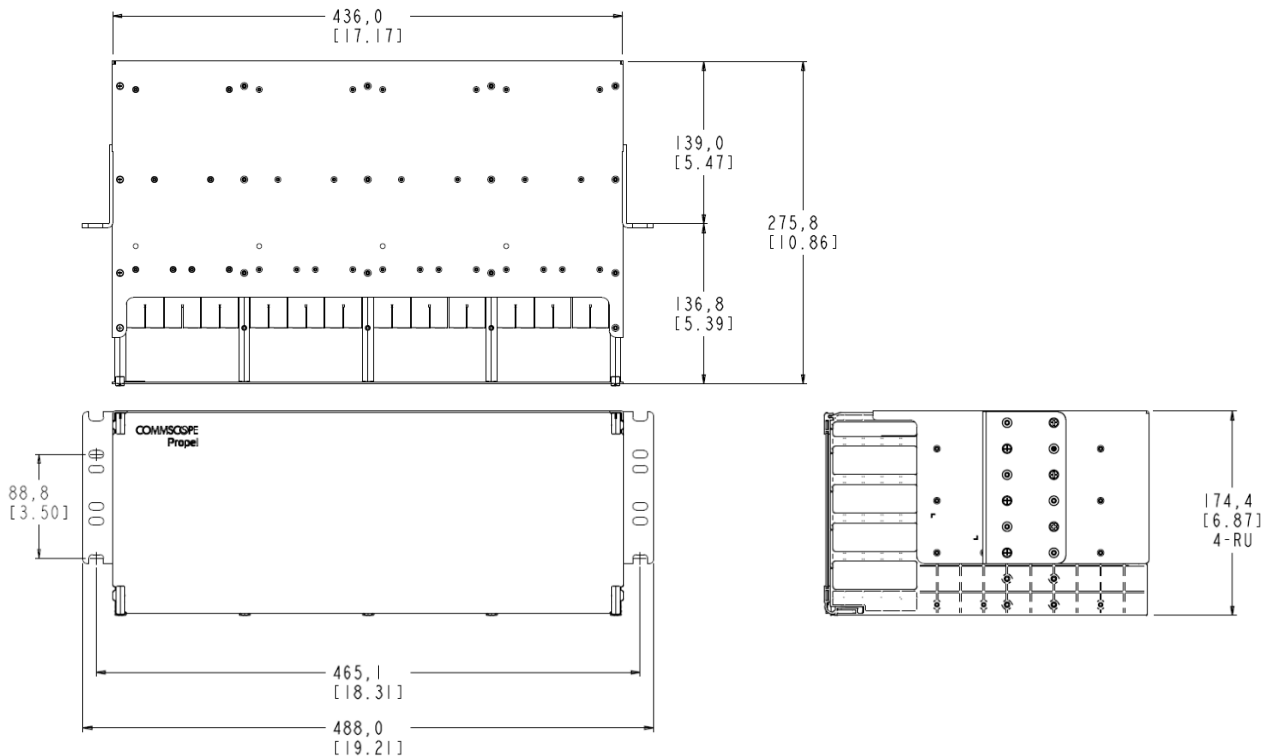

Figure 15. PPL-FA-4U-HCM Panel Dimensions

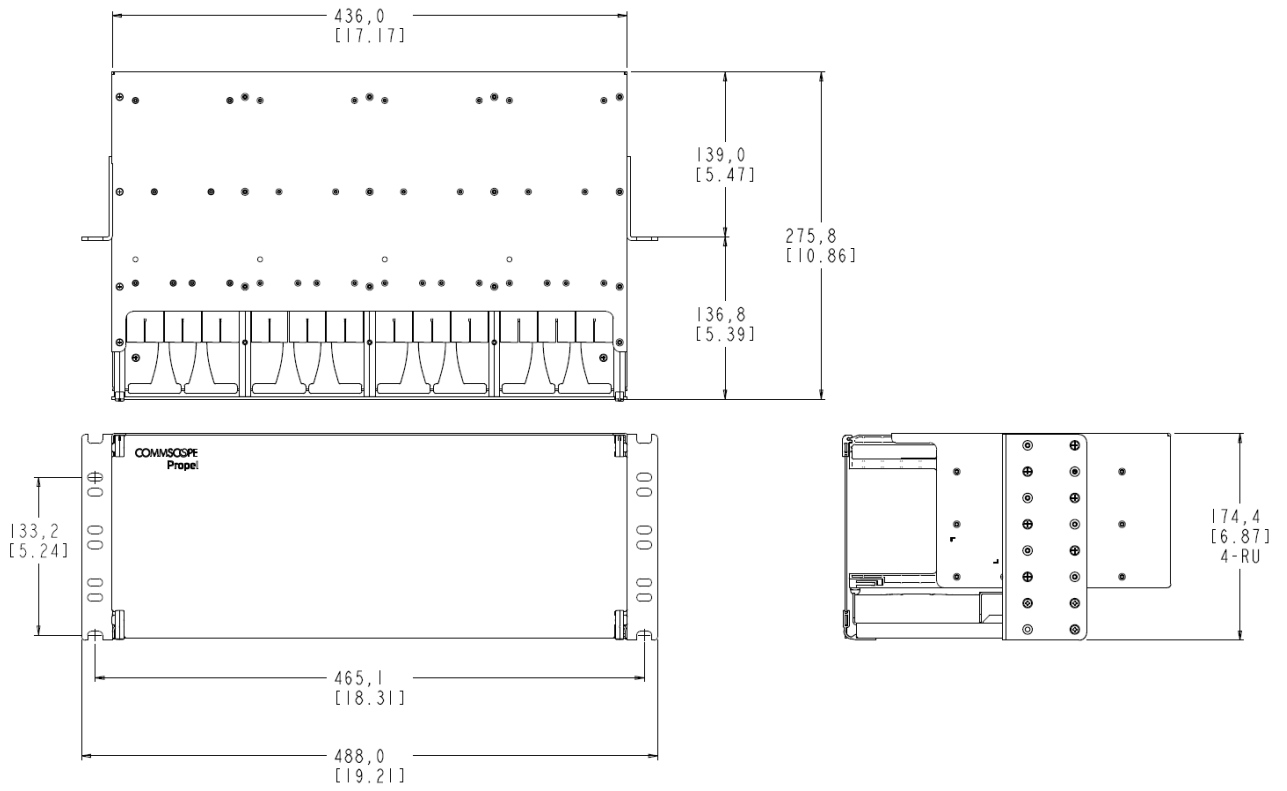

Figure 16. PPL-FA-4U-VCM Panel Dimensions

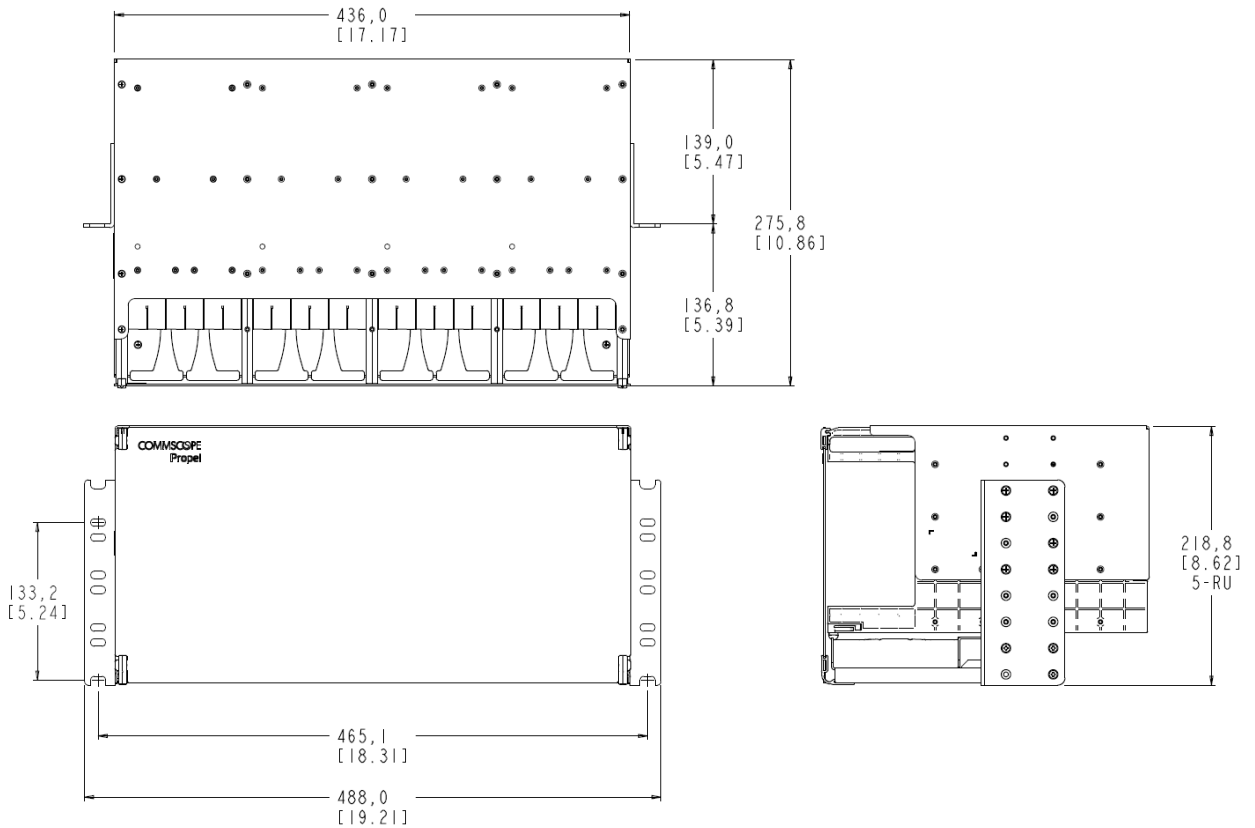

Figure 17. PPL-FA-5U-VCM Panel Dimensions

Table 5 lists the installation specifications for the Propel Front Access Panels.

**Table 5. Propel Front Access Panel Specifications**

Parameter	3RU HCM	4RU HCM	4RU VCM	5RU VCM
Catalog Number	PPL-FA-3U-HCM	PPL-FA-4U-HCM	PPL-FA-4U-VCM	PPL-FA-5U-VCM
Height	5.1 in (13.0 cm)	6.9 in (17.4 cm)	6.9 in (17.4 cm)	8.6 in (21.9 cm)
Width	19.2 in (48.8 cm)	19.2 in (48.8 cm)	19.2 in (48.8 cm)	19.2 in (48.8 cm)
Depth	10.9 in (27.6 cm)	10.9 in (27.6 cm)	10.9 in (27.6 cm)	10.9 in (27.6 cm)
Net Weight (Product Only)	7.9 lbs (3.6 kg)	9.1 lbs (4.1 kg)	11.3 lbs (5.1 kg)	12.0 lbs (5.4 kg)
Gross Weight (With Packaging)	16.2 lbs (7.3 kg)	17.1 lbs (7.8 kg)	19.4 lbs (8.8 kg)	19.8 lbs (9.0 kg)
Rack Units	3	4	4	5
Patch Cord Routing Direction	Horizontal	Horizontal	Vertical	Vertical
Maximum Fibers - LC	288	384	288	384
Maximum Fibers - SN	<i>Not Recommended</i>	<i>Not Recommended</i>	576	768
Maximum Fibers - MPO8 Adapter Packs	1,152	1,536	1,152	1,536
Maximum Fibers - MPO12 Adapter Packs	1,728	2,304	1,728	2,304
Maximum Fibers - MPO16 Adapter Packs	2,304	<i>Not Recommended</i>	2,304	<i>Not Recommended</i>
Maximum Panels Per XFrame (40RU)	13	10	10	8

### 3.2 Panel Unpacking and Inspection

Unpack the Propel Front Access Panel by first removing the Quick Start Guide (TC-01001512-IP or TC-01001513-IP) and top foam from the box. Then, use the panel mounting brackets to lift the panel out of the bottom foam. Locate and remove the hardware pack prior to recycling the packaging.

**NOTE:** The foam inserts highlighted in [Figure 18](#) may or may not be included, depending on the panel size and type.

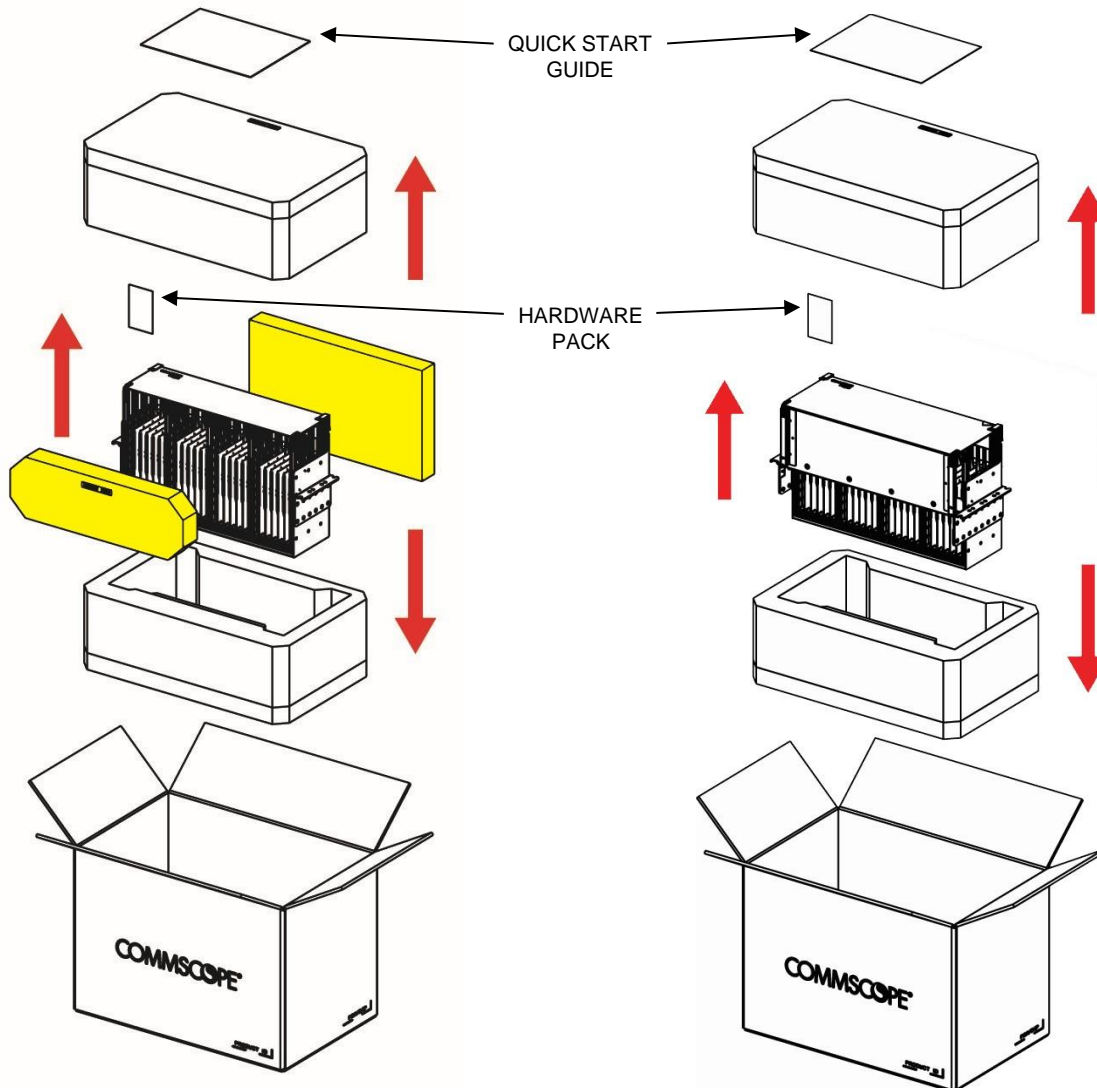

Figure 18. Propel Front Access Panel Unpacking

### 3.3 Panel Installation on Frame

**IMPORTANT:** Propel XFrame rear covers cannot be assembled or removed with panels installed. Fully assemble and secure frame before mounting panels.

Mount the panel on the frame by installing four sets of provided cage nuts and screws in the following steps.

- Determine mounting location on frame (i.e. RUs panel will occupy). Panel top will align with topmost RU marking. Brackets may not span all RUs (see [Figure 19](#)).
- Install cage nuts into square holes on frame.

**NOTE:** Refer to [Figure 19](#) for guidance on cage nut locations based on panel used.

- Install the bottom two screws, leaving a gap between the rack and screwhead.



d) Set the panel on top of the partially installed screws, making use of the half-slot at the bottom of each mounting bracket.

e) Install the top two screws, tightening fully.

**NOTE:** Do not fasten the panel using the top U-shaped hole on the mounting bracket. Use the topmost full hole of the bracket instead.

f) Fully tighten the bottom two screws.

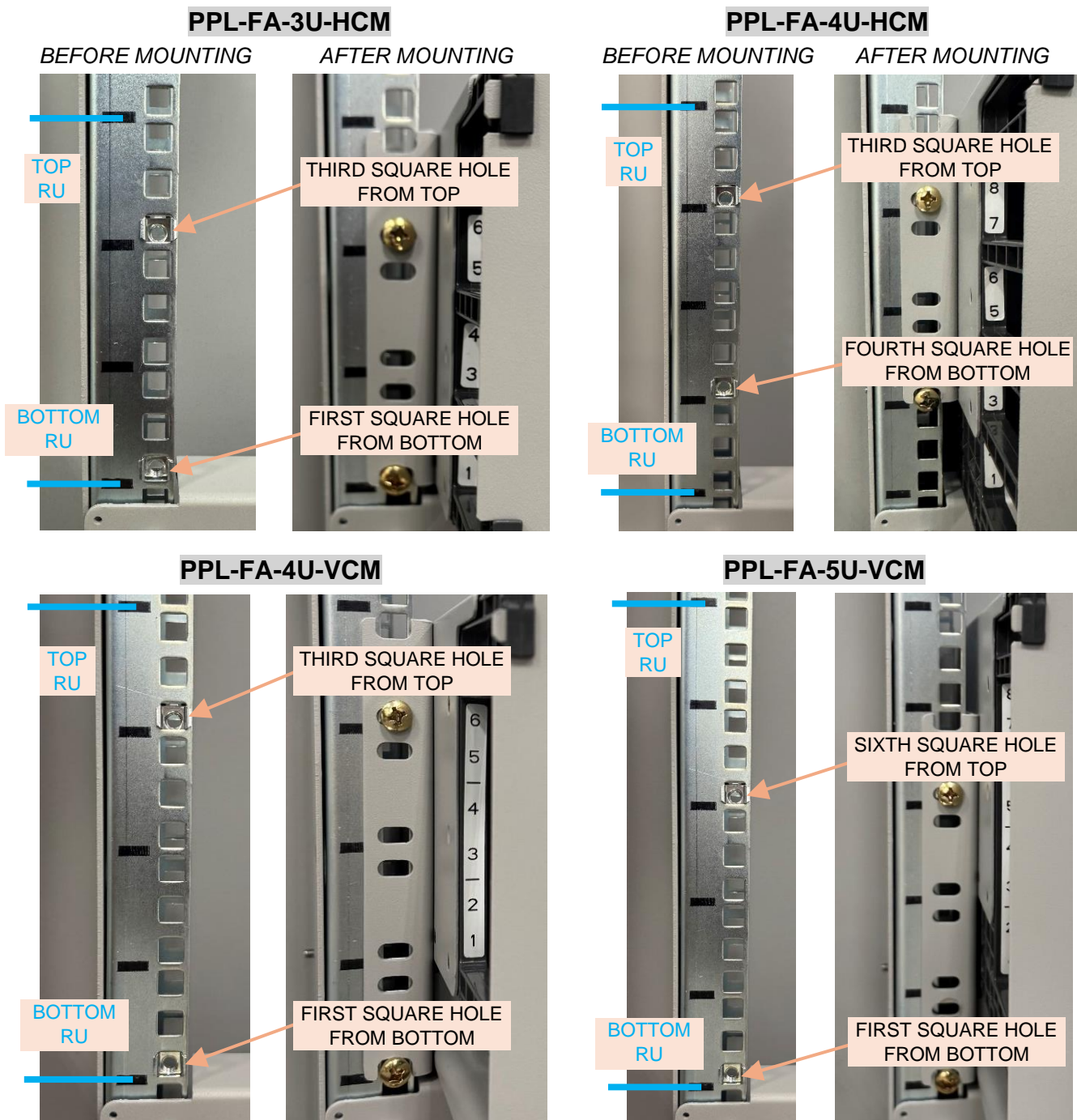
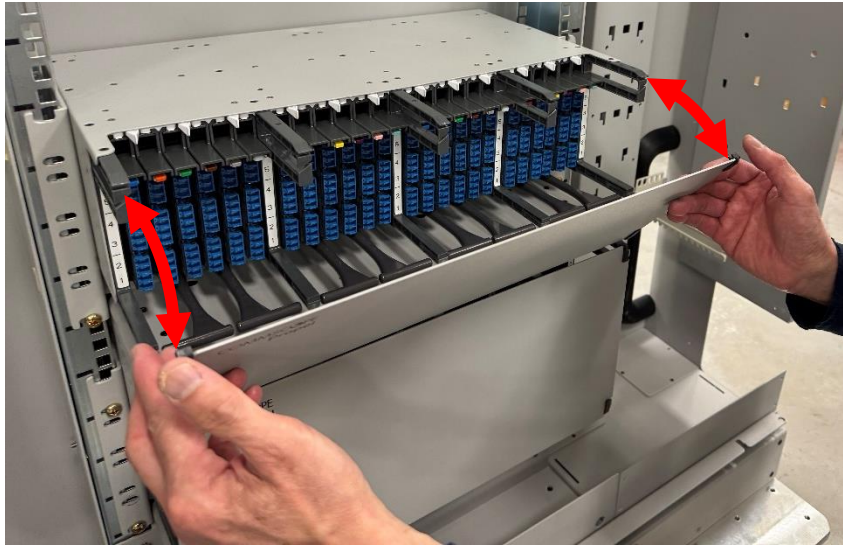

Figure 19. Cage Nut Locations Per Panel Type and Mounting RUs

## 4 Operational Details

### 4.1 Propel Front Access Panels Operation

To open the panel, hold the top corners of the front cover and pull outward so it swings down. To close it, swing the cover up and press the top corners until they click into place.



**Figure 20. Panel Door Operation**

To remove a cartridge from the panel, deflect the adjacent latch and pull the cartridge out. [Figure 21](#) shows this process.

**NOTE:** Each white latch secures two cartridges. To remove the left cartridge, move the latch to the right. To remove the right cartridge, move the latch to the left.

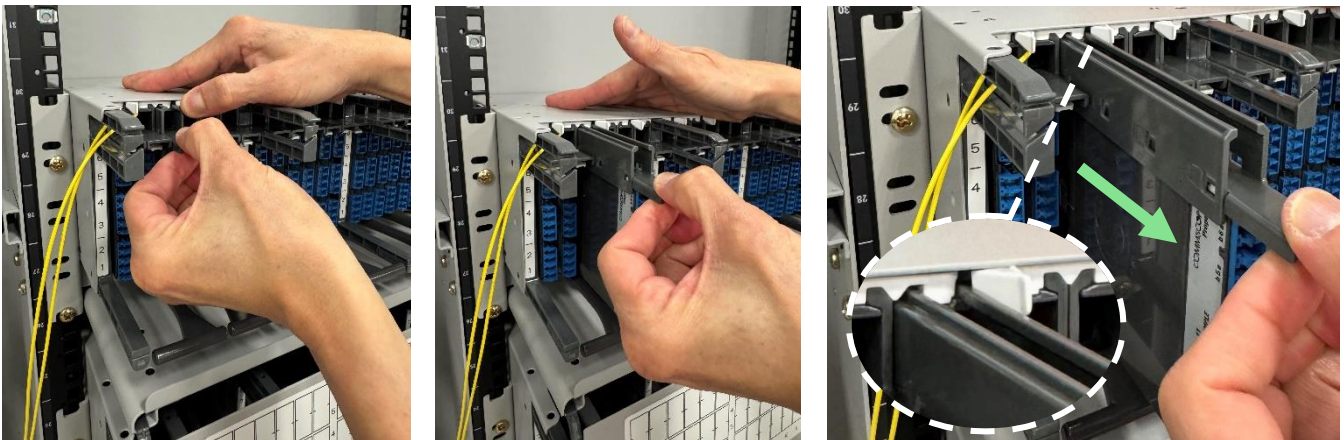

**Figure 21. Removing Cartridge from PPL-FA Panel**

Next, install a Propel connection component into the panel cartridge. The entry (rear) cable connections can be made before or after the connection component is assembled to the cartridge.

Follow the steps outlined below and in [Figure 22](#).

- 1) Mate entry cable connector(s) to the rear port(s) of the Propel connection component.
- 2) Route entry cable(s) around the nearest cartridge radius limiter, through the rear gap, and along the top channel to the front.
- 3) Align the Propel connection component slots with the rail features of the cartridge.
- 4) Slide the Propel connection component and cartridge together until a click is heard.

**NOTE:** When routing fiber-optic cables, handle with care and adhere to the minimum bend radius specified for the cable. Avoid sharp bends, pinch points, and excessive tension.

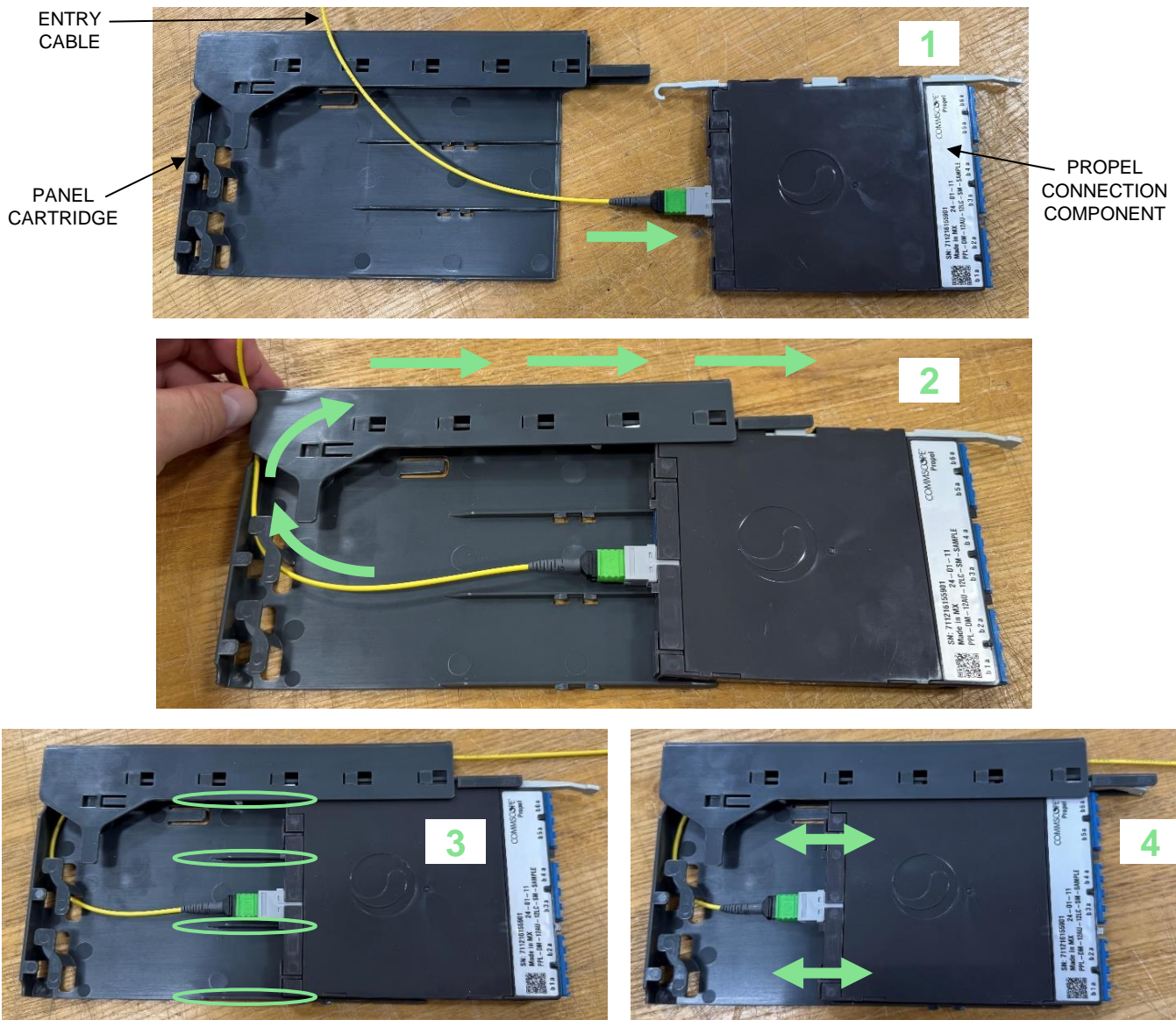
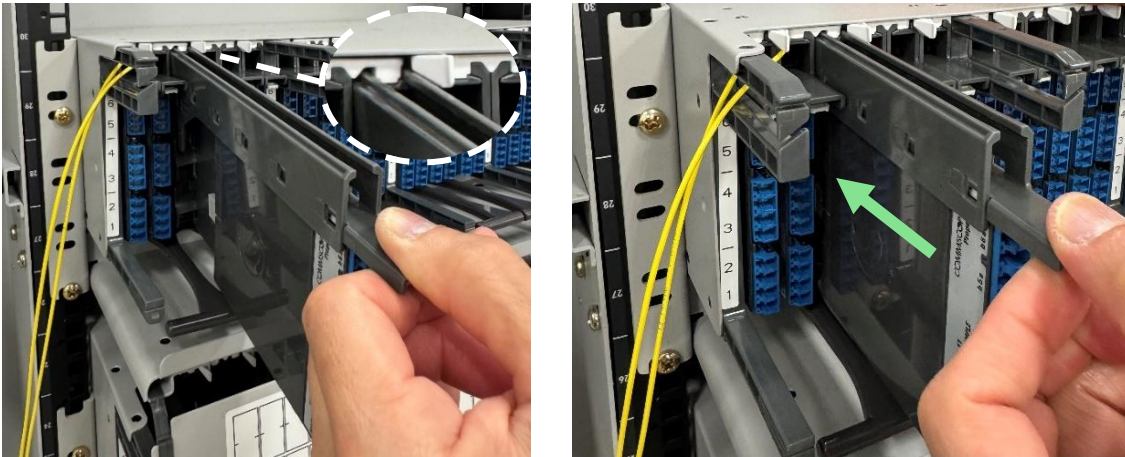

Figure 22. Installing a Propel Connection Component into Cartridge

To re-install a populated cartridge into the panel, align the top channel of the cartridge with the panel slots in its original location. Tip the cartridge slightly downward to facilitate alignment. Push the cartridge from the front, sliding it to the far back of the panel. When a cartridge is fully installed, the adjacent latch will deflect back to neutral. [Figure 23](#) shows this process.



**Figure 23. Installing Cartridge into PPL-FA Panel**

Finally, route the entry cable(s) through the top cable management rings of the panel and into the Cable Entry side of the frame. Further frame cable management instructions are included in the next section.

#### **4.2 Propel XFrame with Panels Operation**

Once a Propel Front Access Panel is installed into the Propel XFrame, and connection components with entry cables are added, route the entry cables into the Cable Entry side manager of the frame. This could be either the Left or Right side, depending on your Frame Configuration (see [Section 2.5](#)).

Then connect patch cords as needed, following best practices (see [Sections 4.3-4.5](#)).

#### **4.3 General Best Practices**

Best practices for deploying the Propel XFrame and Panels are covered in this section. Most points relate to entry cable routing, patch cord routing, and order of operations.

- If possible, install the bottom panel first and progress towards the top of the frame.
- Cartridges can be installed in the panel with or without patch cords connected.
- Label ports on the inside of the panel front doors according to your network labeling scheme.
- ENTRY CABLES – Secure each entry cable to a cable attachment bracket using zip-ties, hook-and-loop straps, or other fastening method.

- ENTRY CABLES – Recommended breakout length is **60 inches** (1.5 meters).
- ENTRY CABLES – Recommended cable attachment bracket for each entry cable depends on the entry opening used (top or bottom) and the entry RU of the frame. See [Figure 24](#) for guidance.
- PATCH CORDS – For each patch cord, use the routing spool A-G that results in the cable slack transitioning between frames in the Drip Loop Target Zone, shown in [Figure 25](#).
- PATCH CORDS – If the Offset spools do not accommodate all slack, route patch cords around the Return spools, following the dashed path\* in [Figure 25](#).
- PATCH CORDS – Recommended patch cord length for a single frame or dual frame configuration is **5 meters** (16.4 feet).
- PATCH CORDS – Recommended patch cord length for crossing a lineup of more than two frames is  
 $17 + 4 \cdot [\# \text{ of frames bypassed}] \text{ feet}$   
 $(5.2 + 1.2 \cdot [\# \text{ of frames bypassed}]) \text{ meters}$ .

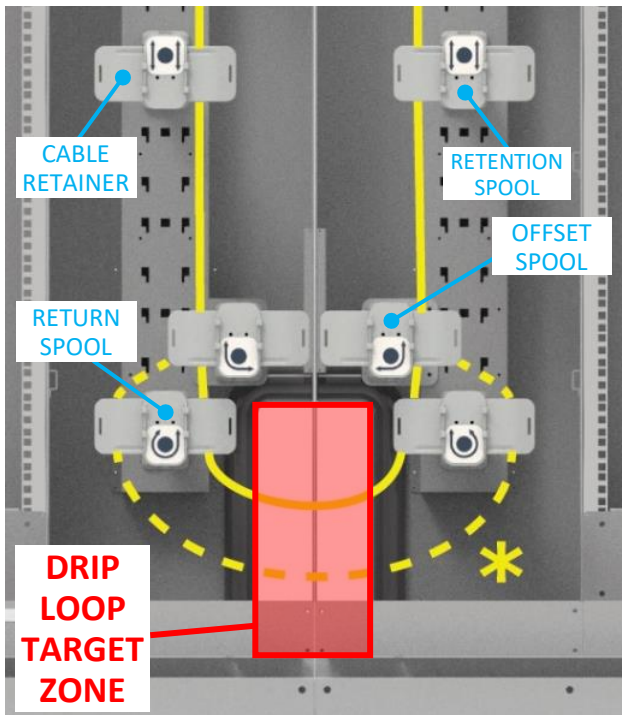

Figure 25. Cable Transition Between Frames

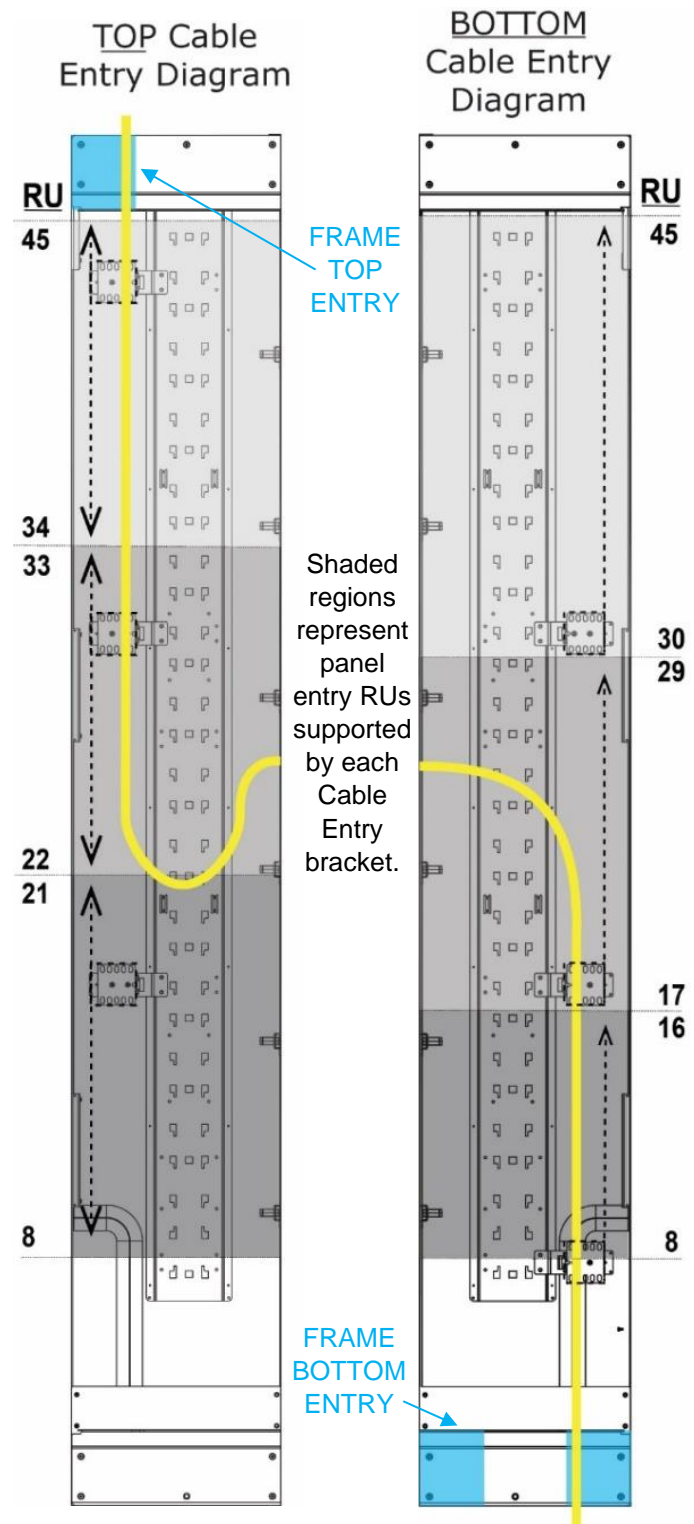

Figure 24. Cable Entry Diagrams

#### 4.4 HCM Panels Best Practices

This section details best practices specific to the use of Horizontal Cable Management (HCM) Panels with the Propel XFrame.

- PATCH CORDS – For HCM Panels, it is critical to begin patching on the Patch Cord Management side of the panel and work towards the Cable Entry side. See [Figure 26](#).
- PATCH CORDS – For HCM Panels, route patch cords across the front of the panel, through the cable management rings, and into the Patch Cord Management side of the frame. See [Figure 26](#).
- PATCH CORDS – Recommended routing spool A-G for each HCM patch cord depends on the panel size and location in the frame. Refer to [Section 4.6](#).
- PATCH CORDS – Moves, adds and changes of fiber components can be challenging with HCM Panels. Take caution to avoid disturbing surrounding connections. Where significant moves, adds and changes are anticipated, VCM Panels are recommended.

**⚠ CAUTION** - Disconnected optical components may emit invisible radiation that can damage your eyes. Avoid looking directly into any optical component. Permanent retinal damage is possible. If exposure to laser radiation is suspected, consult a physician.

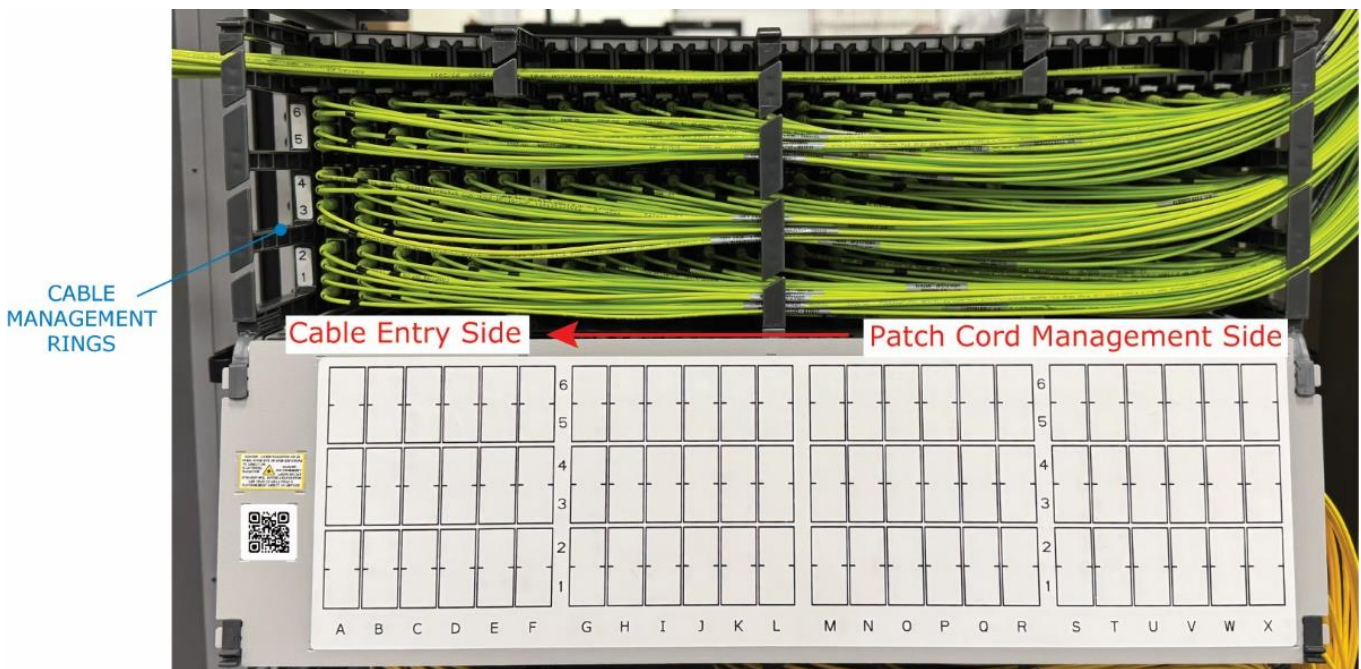

**Figure 26. Example of Fully-Patched HCM Panel**

## 4.5 VCM Panels Best Practices

This section details best practices specific to the use of Vertical Cable Management (VCM) Panels with the Propel XFrame.

- PATCH CORDS – For VCM Panels, it is recommended to begin patching on the Cable Entry side of the panel and work towards the Patch Cord Management side. See [Figure 27](#).
- PATCH CORDS – For VCM Panels, route patch cords down the front of the panel, through the cable management trough, and into the Patch Cord Management side of the frame. See [Figure 27](#).
- PATCH CORDS – Recommended routing spool A-G for each VCM patch cord depends on the panel size and location in the frame. Refer to [Section 4.7](#).
- PATCH CORDS – Moves, adds and changes of fiber components are facilitated by the design of VCM Panels. Even so, take caution of surrounding connections.

**⚠ CAUTION** - Disconnected optical components may emit invisible radiation that can damage your eyes. Avoid looking directly into any optical component. Permanent retinal damage is possible. If exposure to laser radiation is suspected, consult a physician.

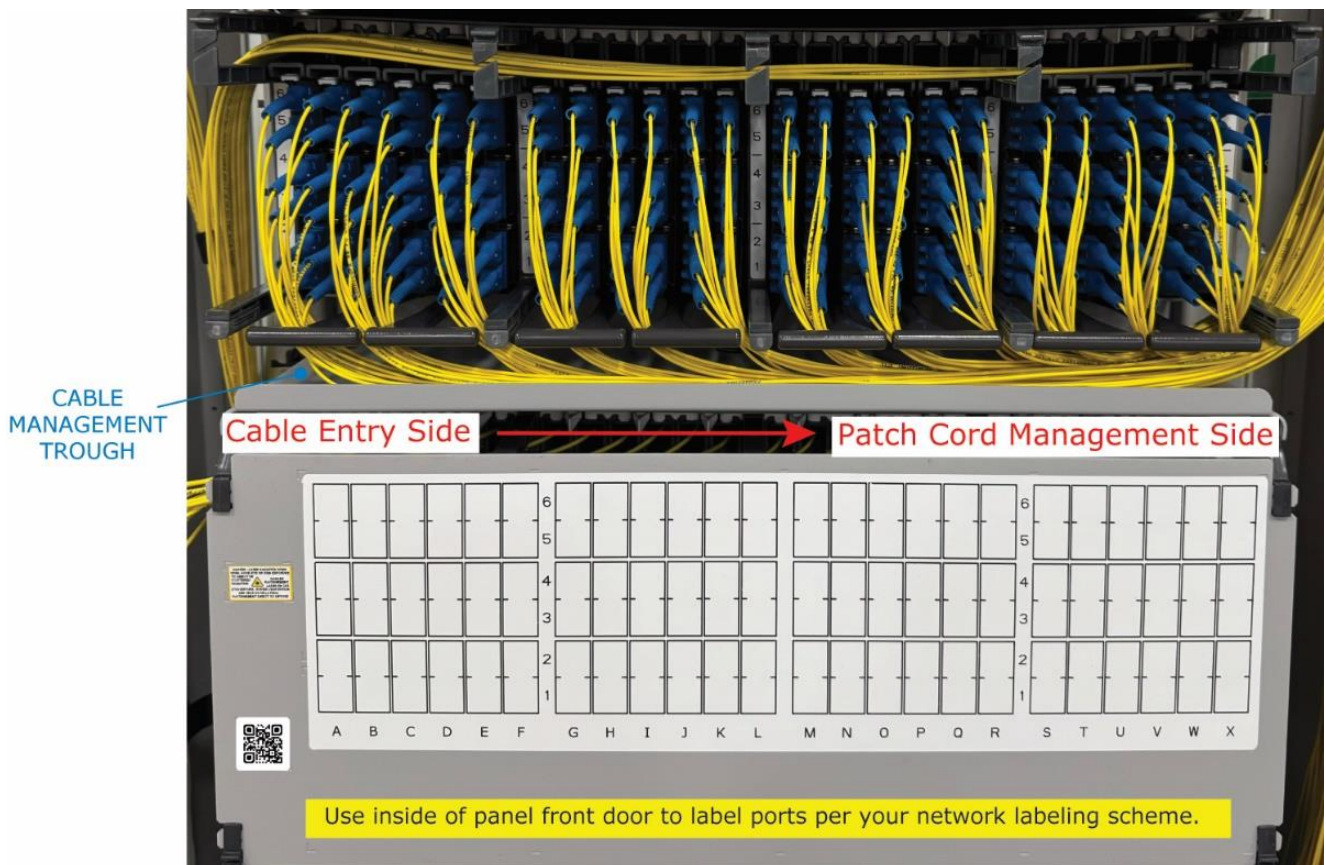

**Figure 27. Example of Fully-Patched VCM Panel**

4.6 Horizontal Cable Management (HCM) Panels – Patch Cord Routing Diagrams

PPL-FA-3U-HCM (760258354)

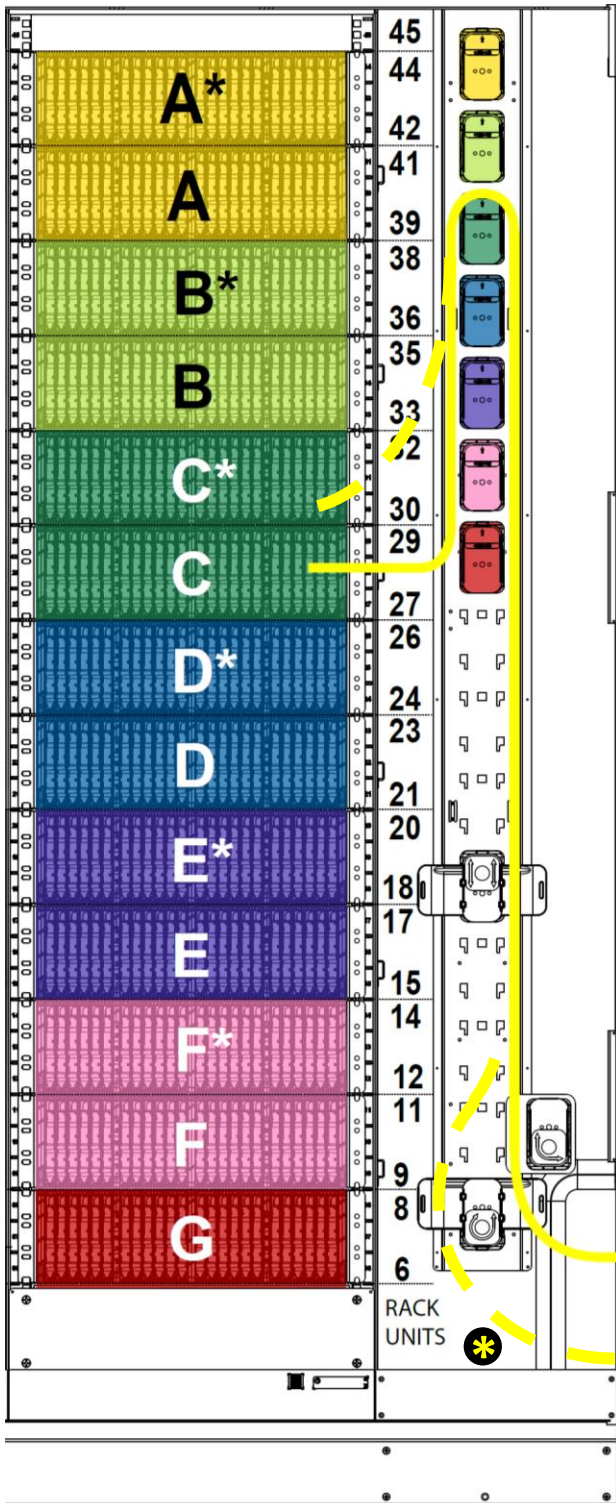

PPL-FA-4U-HCM (760258356)

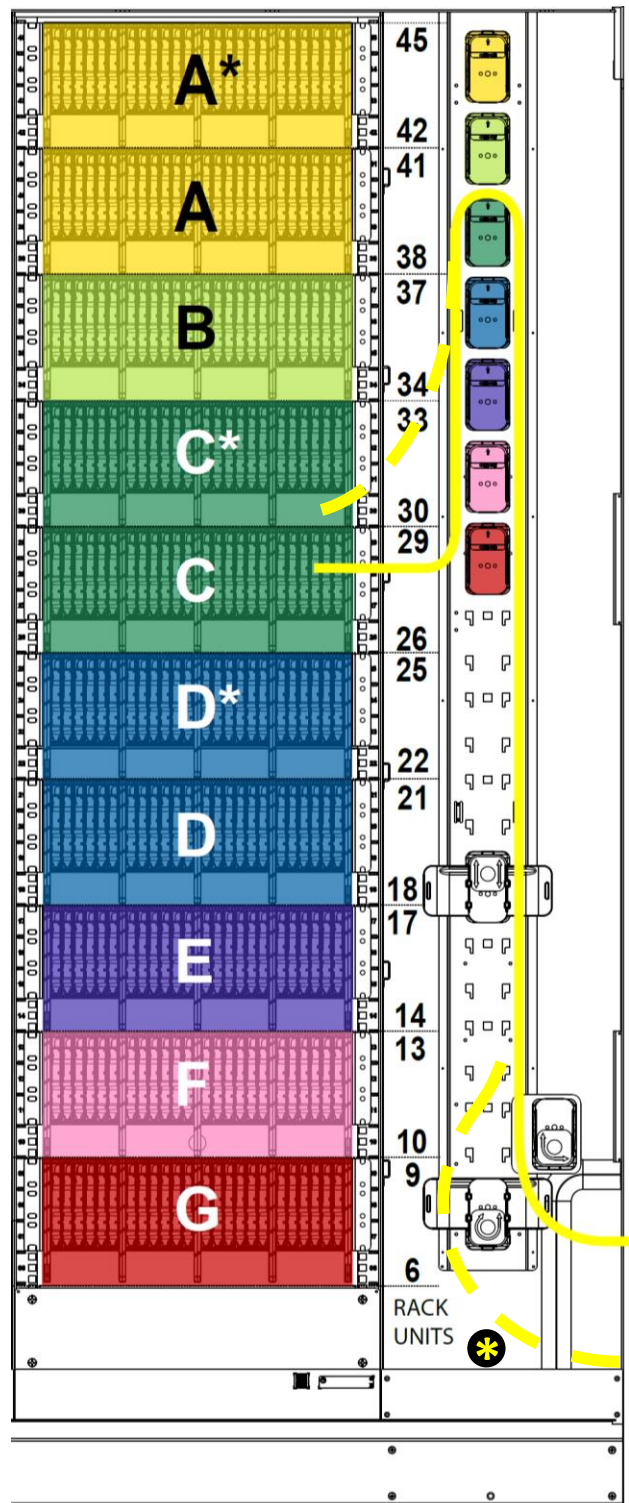

Figure 28. HCM Patch Cord Routing Diagrams (Multiple Frames)

\* Alternate Patch Cord Routing Path



4.7 Vertical Cable Management (VCM) Panels – Patch Cord Routing Diagrams

PPL-FA-4U-VCM (760258355)

PPL-FA-5U-VCM (760258357)

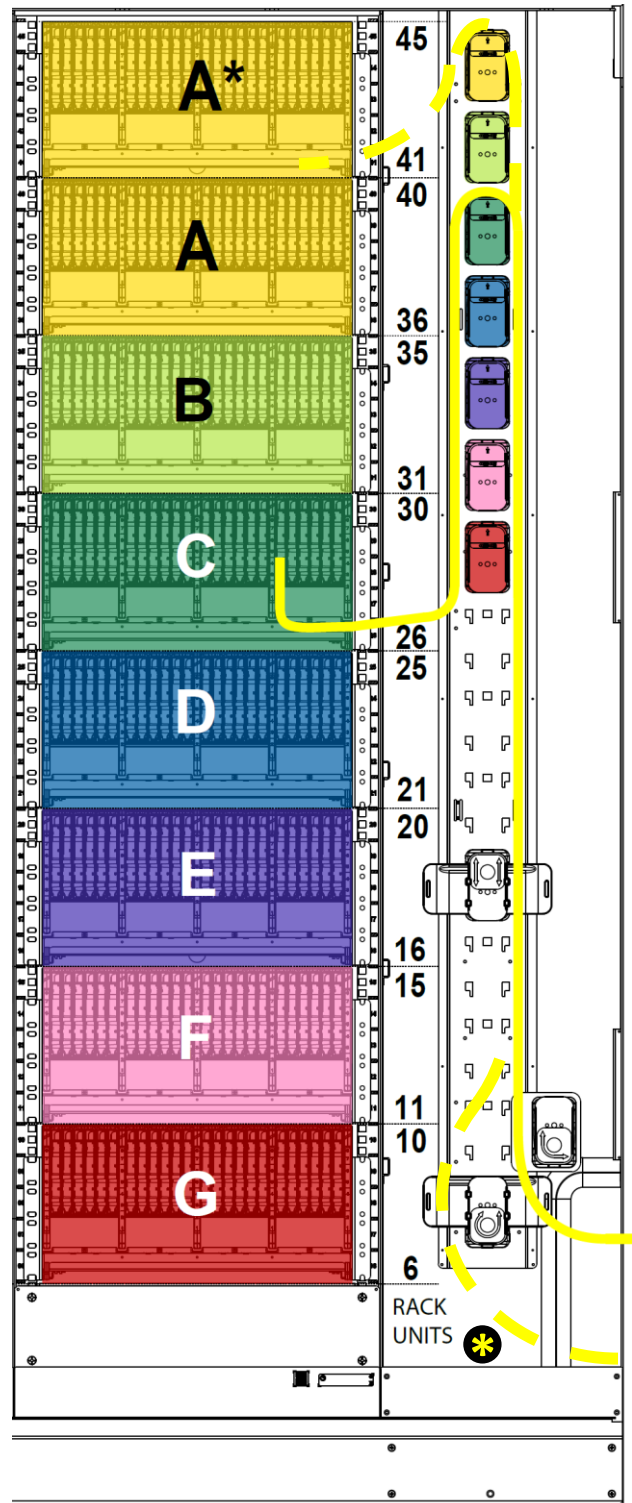
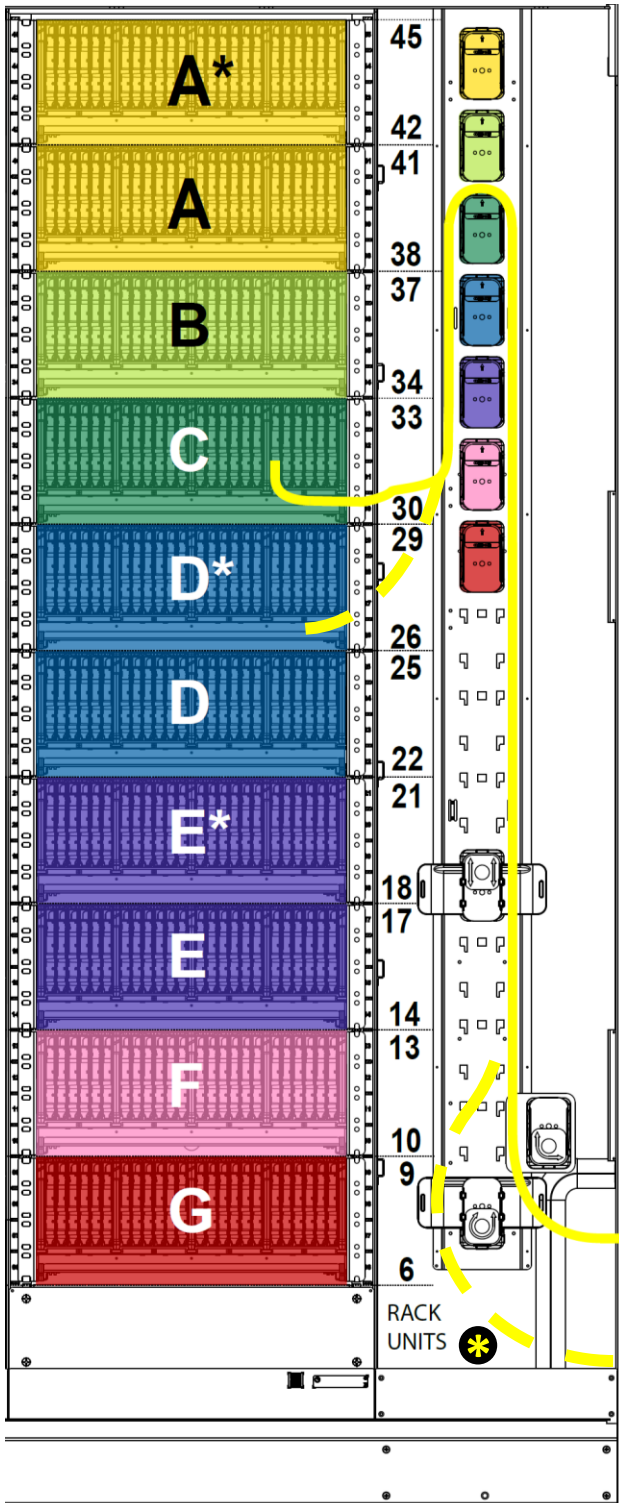
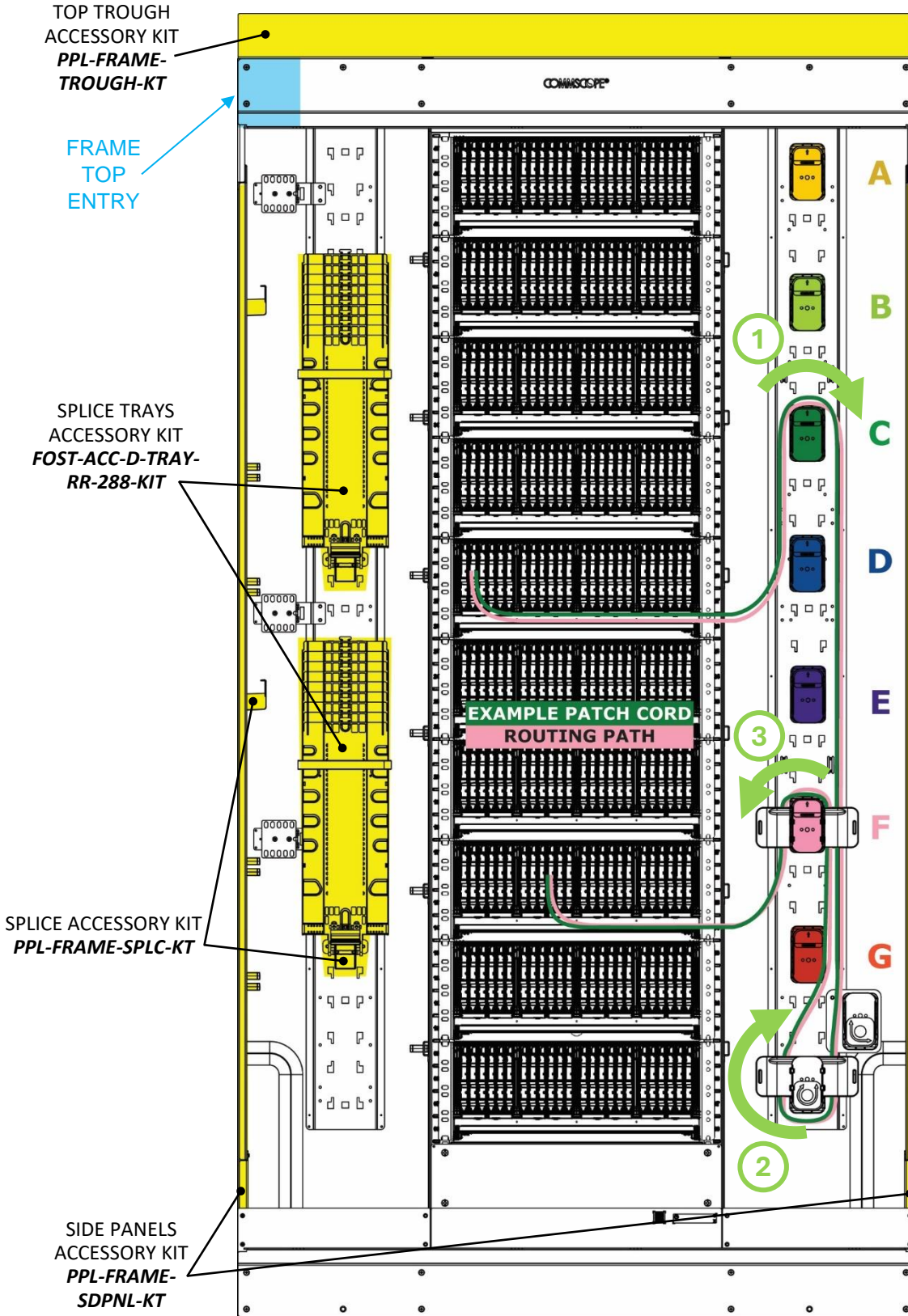

Figure 29. VCM Patch Cord Routing Diagrams (Multiple Frames)

\* Alternate Patch Cord Routing Path

### 4.8 Stand-Alone Frame – Patch Cord Routing Diagram



For stand-alone frame applications, redistribute the spools A-G as described in Section 2.5 and shown to the left.

Use the dedicated Return spool, or spools B-G, to accommodate patch cord slack within the frame.

Figure 30 shows an example patch cord routing path for a stand-alone frame.

Figure 30 also shows the frame accessories in their installed positions. It is recommended to use one Side Panels kit per stand-alone Propel XFrame.

Figure 30. Stand-Alone Frame Patch Cord Routing Example

## 5 Contact Information

- To find out more about CommScope® products, visit us on the web at [www.commscope.com](http://www.commscope.com)
- For technical assistance, customer service, or to report any missing/damaged parts, visit us at <http://www.commscope.com/SupportCenter>