

PFC-S04L16



Powered Fiber Cable, OS2, 4 Fibers, Indoor/Outdoor, 16AWG Conductor, meter, feet

- Easy peel, stranded conductors for maximum cable flexibility and rapid access
- Polarization indentation along one side of the cable for polarity identification
- No special tools or mounting hardware required - usage of a standard "FTTH" pressure clamp for aerial installation
- Easy split of cable into three separate sections for separate routing in closures, as needed for installation
- Riser/LSZH jacket for indoor/outdoor applications
- Cable should not be installed below grade where the cable is immersed or is continually in contact with water or moisture

Product Classification

Regional Availability

Asia | Australia/New Zealand | EMEA | Latin America | North America

Product Type

Hybrid cable, fiber and power

Ordering Note

Minimum order quantity is 500 meter

General Specifications

Cable Type

Stranded indoor/outdoor

Fiber Short Description

PFC-L16

Jacket Color

Black

Total Fiber Count

4

Dimensions

Height Over Jacket

4.318 mm | 0.17 in

Width Over Jacket

11.43 mm | 0.45 in

Conductor Gauge

16 AWG

Outline Drawing

PFC-S04L16

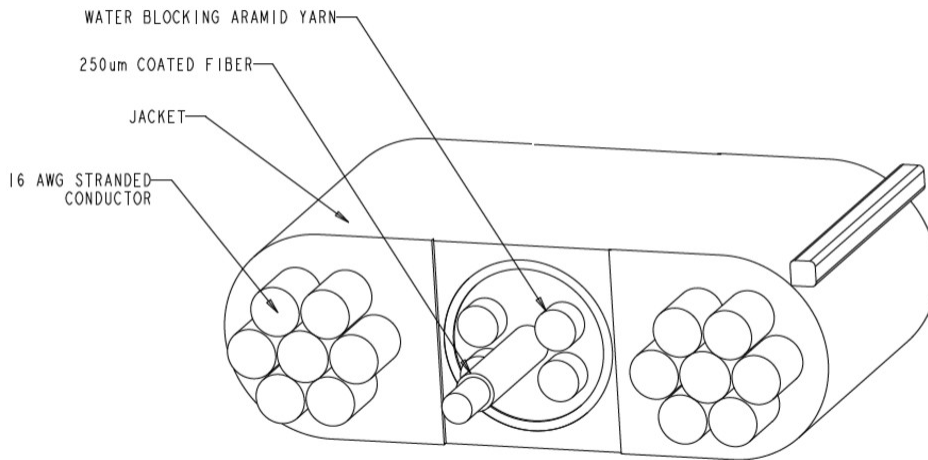

Mechanical Specifications

Minimum Bend Radius, loaded	88.9 mm 3.5 in
Minimum Bend Radius, unloaded	45.72 mm 1.8 in
Tensile Load, long term, maximum	133.447 N 30 lbf
Tensile Load, short term, maximum	440.374 N 99 lbf
Vertical Rise, maximum	122.011 m 400.3 ft

Optical Specifications

Fiber Type	G.657.A2, TeraSPEED® OS2
-------------------	----------------------------

Environmental Specifications

Installation temperature	-10 °C to +60 °C (+14 °F to +140 °F)
Operating Temperature	-40 °C to +70 °C (-40 °F to +158 °F)
Storage Temperature	-40 °C to +70 °C (-40 °F to +158 °F)
Cable Qualification Standards	Telcordia GR-20-CORE Issue 4
EN50575 CPR Cable EuroClass Fire Performance	Dca
EN50575 CPR Cable EuroClass Smoke Rating	s1a
EN50575 CPR Cable EuroClass Droplets Rating	d1
EN50575 CPR Cable EuroClass Acidity Rating	a1
Environmental Space	Low Smoke Zero Halogen (LSZH) Riser

PFC-S04L16

Flame Test Method

IEC 60332-1-2 | IEC 60754-2 | IEC 61034-2 | NFPA 130 | UL 1666 | UL 444

Jacket UV Resistance

UV stabilized

Packaging and Weights

Cable weight

69.944 kg/km | 47 lb/kft

Regulatory Compliance/Certifications

Agency

Classification

CENELEC

EN 50575 compliant, Declaration of Performance (DoP) available



Included Products

CS-8G-PFC

- Enhanced Low Macrobending, Zero Water Peak, Dispersion-Unshifted Singlemode Fiber (ITU-T G.657.A2, B2)

CS-8G-PFC

Enhanced Low Macrobending, Zero Water Peak, Dispersion-Unshifted Singlemode Fiber (ITU-T G.657.A2, B2)

Product Classification

Portfolio	CommScope®
Product Type	Optical fiber

General Specifications

Cladding Diameter	125 µm
Cladding Diameter Tolerance	±0.7 µm
Cladding Non-Circularity, maximum	0.7 %
Coating Diameter (Colored)	254 µm
Coating Diameter (Uncolored)	240 µm
Coating Diameter Tolerance (Colored)	±7 µm
Coating Diameter Tolerance (Uncolored)	±5 µm
Coating/Cladding Concentricity Error, maximum	12 µm
Core/Clad Offset, maximum	0.5 µm
Proof Test	689.476 N/mm ² 100000 psi

Dimensions

Fiber Curl, minimum	4 m 13.123 ft
----------------------------	-----------------

Mechanical Specifications

Macrobending, 15 mm Ø mandrel, 1 turn	0.50 dB @ 1,550 nm 1.00 dB @ 1,625 nm
Macrobending, 20 mm Ø mandrel, 1 turn	0.10 dB @ 1,550 nm 0.20 dB @ 1,625 nm
Macrobending, 30 mm Ø mandrel, 10 turns	0.03 dB @ 1,550 nm 0.10 dB @ 1,625 nm
Coating Strip Force, maximum	8.9 N 2.001 lbf
Coating Strip Force, minimum	1.3 N 0.292 lbf
Dynamic Fatigue Parameter, minimum	20

Optical Specifications

Cabled Cutoff Wavelength, maximum	1260 nm
Point Defects, maximum	0.1 dB

CS-8G-PFC

Zero Dispersion Slope, maximum	0.092 ps/[km-nm-nm]
Zero Dispersion Wavelength, maximum	1322 nm
Zero Dispersion Wavelength, minimum	1302 nm

Optical Specifications, Wavelength Specific

Attenuation, maximum	0.30 dB/km @ 1,550 nm 0.40 dB/km @ 1,310 nm
Dispersion, maximum	18 ps(nm-km) at 1550 nm 3.5 ps(nm-km) from 1285 nm to 1330 nm at 1310 nm
Index of Refraction	1.467 @ 1,310 nm 1.467 @ 1,385 nm 1.468 @ 1,550 nm
Mode Field Diameter	8.8 μm @ 1,310 nm 9.9 μm @ 1,550 nm
Mode Field Diameter Tolerance	$\pm 0.4 \mu\text{m}$ @ 1310 nm $\pm 0.5 \mu\text{m}$ @ 1550 nm
Polarization Mode Dispersion Link Design Value, maximum	0.06 ps/sqrt(km)
Standards Compliance	ITU-T G.657.A2 ITU-T G.657.B2

Environmental Specifications

Heat Aging, maximum	0.05 dB/km @ 85 °C
Temperature Dependence, maximum	0.05 dB/km
Temperature Humidity Cycling, maximum	0.05 dB/km
Water Immersion, maximum	0.05 dB/km @ 23 °C

Regulatory Compliance/Certifications

Agency	Classification
ISO 9001:2015	Designed, manufactured and/or distributed under this quality management system

* Footnotes

Temperature Dependence, maximum	Temperature dependence is conducted at -60 °C to +85 °C (-76 °F to +185 °F)
Temperature Humidity Cycling, maximum	Temperature humidity cycling is conducted at -10 °C to +85 °C (+14 °F to +185 °F) up to 95% relative humidity