

PFC-S04016



Powered Fiber Cable, OS2, 4 Fibers, Outdoor, 16AWG Conductor, meter, feet

- Easy peel, stranded conductors for maximum cable flexibility and rapid access
- Polarization indentation along one side of the cable for polarity identification
- No special tools or mounting hardware required - usage of a standard "FTTH" pressure clamp for aerial installation
- Easy split of cable into three separate sections for separate routing in closures, as needed for installation
- Polyethylene jacket for outdoor duct or direct buried applications

Product Classification

Regional Availability	Asia Australia/New Zealand EMEA Latin America North America
Product Type	Hybrid cable, fiber and power
Ordering Note	Minimum order quantity is 500 meter

General Specifications

Cable Type	Stranded outdoor
Fiber Short Description	PFC-016
Jacket Color	Black
Total Fiber Count	4

Dimensions

Height Over Jacket	4.318 mm 0.17 in
Width Over Jacket	11.43 mm 0.45 in
Conductor Gauge	16 AWG

Outline Drawing

PFC-S04016

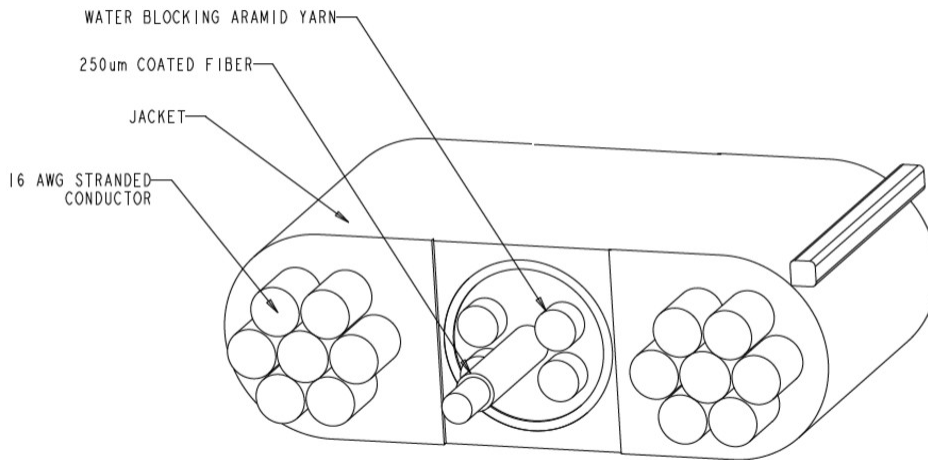

Mechanical Specifications

Minimum Bend Radius, loaded	50.8 mm 2 in
Minimum Bend Radius, unloaded	30.48 mm 1.2 in
Tensile Load, long term, maximum	133.447 N 30 lbf
Tensile Load, short term, maximum	440.374 N 99 lbf
Vertical Rise, maximum	122.011 m 400.3 ft

Optical Specifications

Fiber Type	G.657.A2, TeraSPEED® OS2
-------------------	----------------------------

Environmental Specifications

Installation temperature	-10 °C to +60 °C (+14 °F to +140 °F)
Operating Temperature	-40 °C to +70 °C (-40 °F to +158 °F)
Storage Temperature	-40 °C to +70 °C (-40 °F to +158 °F)
Cable Qualification Standards	Telcordia GR-20-CORE Issue 4
Environmental Space	Outdoor
Jacket UV Resistance	UV stabilized

Packaging and Weights

Cable weight	69.944 kg/km 47 lb/kft
---------------------	--------------------------

PFC-S04016

Regulatory Compliance/Certifications

Agency	Classification
CHINA-ROHS	Below maximum concentration value
REACH-SVHC	Compliant as per SVHC revision on www.commscope.com/ProductCompliance
ROHS	Compliant
UK-ROHS	Compliant



Included Products

CS-8G-PFC	-	Enhanced Low Macrobending, Zero Water Peak, Dispersion-Unshifted Singlemode Fiber (ITU-T G.657.A2, B2)
-----------	---	--

CS-8G-PFC

Enhanced Low Macrobending, Zero Water Peak, Dispersion-Unshifted Singlemode Fiber (ITU-T G.657.A2, B2)

Product Classification

Portfolio	CommScope®
Product Type	Optical fiber

General Specifications

Cladding Diameter	125 µm
Cladding Diameter Tolerance	±0.7 µm
Cladding Non-Circularity, maximum	0.7 %
Coating Diameter (Colored)	254 µm
Coating Diameter (Uncolored)	240 µm
Coating Diameter Tolerance (Colored)	±7 µm
Coating Diameter Tolerance (Uncolored)	±5 µm
Coating/Cladding Concentricity Error, maximum	12 µm
Core/Clad Offset, maximum	0.5 µm
Proof Test	689.476 N/mm ² 100000 psi

Dimensions

Fiber Curl, minimum	4 m 13.123 ft
----------------------------	-----------------

Mechanical Specifications

Macrobending, 15 mm Ø mandrel, 1 turn	0.50 dB @ 1,550 nm 1.00 dB @ 1,625 nm
Macrobending, 20 mm Ø mandrel, 1 turn	0.10 dB @ 1,550 nm 0.20 dB @ 1,625 nm
Macrobending, 30 mm Ø mandrel, 10 turns	0.03 dB @ 1,550 nm 0.10 dB @ 1,625 nm
Coating Strip Force, maximum	8.9 N 2.001 lbf
Coating Strip Force, minimum	1.3 N 0.292 lbf
Dynamic Fatigue Parameter, minimum	20

Optical Specifications

Cabled Cutoff Wavelength, maximum	1260 nm
Point Defects, maximum	0.1 dB

CS-8G-PFC

Zero Dispersion Slope, maximum	0.092 ps/[km-nm-nm]
Zero Dispersion Wavelength, maximum	1322 nm
Zero Dispersion Wavelength, minimum	1302 nm

Optical Specifications, Wavelength Specific

Attenuation, maximum	0.30 dB/km @ 1,550 nm 0.40 dB/km @ 1,310 nm
Dispersion, maximum	18 ps(nm-km) at 1550 nm 3.5 ps(nm-km) from 1285 nm to 1330 nm at 1310 nm
Index of Refraction	1.467 @ 1,310 nm 1.467 @ 1,385 nm 1.468 @ 1,550 nm
Mode Field Diameter	8.8 μm @ 1,310 nm 9.9 μm @ 1,550 nm
Mode Field Diameter Tolerance	$\pm 0.4 \mu\text{m}$ @ 1310 nm $\pm 0.5 \mu\text{m}$ @ 1550 nm
Polarization Mode Dispersion Link Design Value, maximum	0.06 ps/sqrt(km)
Standards Compliance	ITU-T G.657.A2 ITU-T G.657.B2

Environmental Specifications

Heat Aging, maximum	0.05 dB/km @ 85 °C
Temperature Dependence, maximum	0.05 dB/km
Temperature Humidity Cycling, maximum	0.05 dB/km
Water Immersion, maximum	0.05 dB/km @ 23 °C

Regulatory Compliance/Certifications

Agency	Classification
ISO 9001:2015	Designed, manufactured and/or distributed under this quality management system

* Footnotes

Temperature Dependence, maximum	Temperature dependence is conducted at -60 °C to +85 °C (-76 °F to +185 °F)
Temperature Humidity Cycling, maximum	Temperature humidity cycling is conducted at -10 °C to +85 °C (+14 °F to +185 °F) up to 95% relative humidity