

L4P43A-PNF-5M

LDF4-50A SureFlex® Jumper with interface type N Female, 5 m



Product Classification

Product Type	Wireless transmission cable assembly
Product Brand	HELIAX® SureFlex®
Product Series	LDF4-50A

General Specifications

Body Style, Connector A	Straight
Interface, Connector A	N Female
Interface, Connector B	Sold separately
Specification Sheet Revision Level	A

Dimensions

Length	5 m 16.404 ft
Nominal Size	1/2 in

Electrical Specifications

DTF, Connector A	-32 dB
-------------------------	--------

VSWR/Return Loss

Frequency Band	VSWR	Return Loss (dB)
710–806 MHz	1.201	20.79
806–970 MHz	1.15	23.13
1420–1530 MHz	1.15	23.13
1910–2180 MHz	1.15	23.13
2535–2655 MHz	1.201	20.79
3400–3800 MHz	1.25	19.08
4400–4900 MHz	1.41	15.56

Jumper Assembly Sample Label

L4P43A-PNF-5M



Environmental Specifications

Immersion Test Method

Meets IEC 60529:2001, IP68 in mated condition

Regulatory Compliance/Certifications

Agency

ISO 9001:2015

Classification

Designed, manufactured and/or distributed under this quality management system

Included Products

- | | | |
|----------|---|---|
| L4PNM | - | Type N Male for 1/2 in LDF4-50A cable |
| L4PNM-H | - | Type N Male for 1/2 in LDF4-50A cable. Only available through distribution |
| LDF4-50A | - | LDF4-50A, HELIAX® Low Density Foam Coaxial Cable, corrugated copper, 1/2 in, black PE jacket Halogen free jacketing non-fire-retardant (General propose cable for outdoor use only) |

L4PNM

Type N Male for 1/2 in LDF4-50A cable

Product Classification

Product Type	Wireless and radiating connector
Product Brand	HELIAX®

General Specifications

Body Style	Straight
Cable Family	LDF4-50A
Inner Contact Attachment Method	Solder
Inner Contact Plating	Gold
Interface	N Male
Mounting Angle	Straight
Outer Contact Attachment Method	Self-flare
Outer Contact Plating	Trimetal
Pressurizable	No

Dimensions

Length	65.79 mm 2.59 in
Diameter	23.11 mm 0.91 in
Nominal Size	1/2 in

Outline Drawing

L4PNM

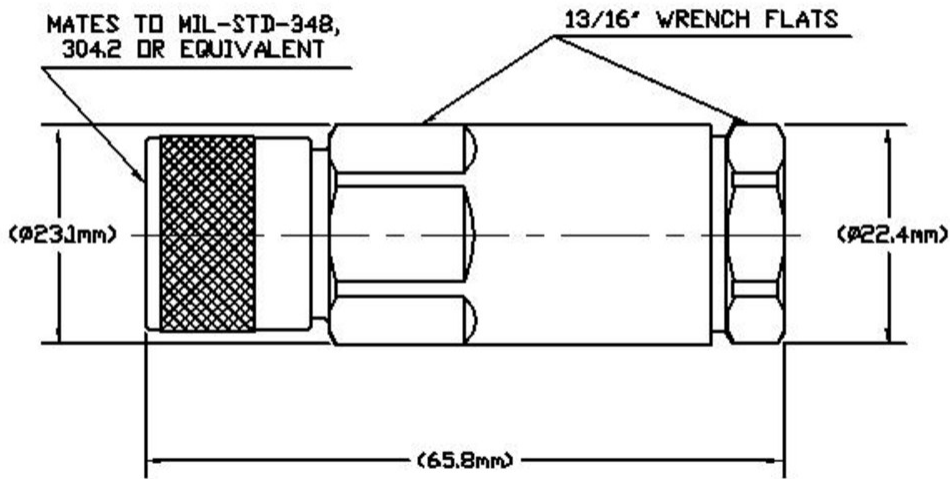

Electrical Specifications

3rd Order IMD at Frequency	-116 dBm @ 910 MHz
3rd Order IMD Test Method	Two +43 dBm carriers
Insertion Loss Coefficient, typical	0.05
Cable Impedance	50 ohm
Connector Impedance	50 ohm
Inner Contact Resistance, maximum	2 mOhm
Operating Frequency Band	0 – 8800 MHz
Outer Contact Resistance, maximum	0.3 mOhm
RF Operating Voltage, maximum (vrms)	707 V

VSWR/Return Loss

Frequency Band	VSWR	Return Loss (dB)
3.5–4.4 GHz	1.152	23.02
45–920 MHz	1.036	35.05
920–2700 MHz	1.058	31
2700–3500 MHz	1.106	25.96
4400–5300 MHz	1.196	20.99
5300–6200 MHz	1.222	20.01
6200–8800 MHz	1.29	18

L4PNM

Mechanical Specifications

Attachment Durability	25 cycles
Connector Retention Tensile Force	889.64 N 200 lbf
Connector Retention Torque	5.42 N-m 47.998 in lb
Coupling Nut Proof Torque	4.52 N-m 39.997 in lb
Coupling Nut Retention Force	444.82 N 100 lbf
Coupling Nut Retention Force Method	MIL-C-39012C-3.25, 4.6.22
Interface Durability	500 cycles
Interface Durability Method	IEC 61169-16:9.5

Environmental Specifications

Attenuation, Ambient Temperature	20 °C 68 °F
Average Power, Ambient Temperature	40 °C 104 °F

Packaging and Weights

Weight, net	108.86 g 0.24 lb
--------------------	--------------------

Regulatory Compliance/Certifications

Agency	Classification
CHINA-ROHS	Below maximum concentration value
ROHS	Compliant
UK-ROHS	Compliant



* Footnotes

Insertion Loss Coefficient, typical 0.05√freq (GHz) (not applicable for elliptical waveguide)

L4PNM-H



Type N Male for 1/2 in LDF4-50A cable. Only available through distribution

Product Classification

Product Type	Wireless and radiating connector
Product Brand	HELIAX®
Product Series	LDF4-50A
Ordering Note	ANDREW® non-standard product

General Specifications

Body Style	Straight
Cable Family	LDF4-50A
Inner Contact Attachment Method	Solder
Inner Contact Plating	Gold
Interface	N Male
Mounting Angle	Straight
Outer Contact Attachment Method	Self-flare
Outer Contact Plating	Trimetal
Pressurizable	No

Dimensions

Length	66.04 mm 2.6 in
Diameter	25.4 mm 1 in
Nominal Size	1/2 in

Electrical Specifications

Insertion Loss Coefficient, typical	0.05
Cable Impedance	50 ohm
Connector Impedance	50 ohm
Inner Contact Resistance, maximum	2 mOhm
Operating Frequency Band	0 – 8800 MHz

L4PNM-H

Outer Contact Resistance, maximum	0.3 mOhm
RF Operating Voltage, maximum (vrms)	707 V

VSWR/Return Loss

Frequency Band	VSWR	Return Loss (dB)
3.5–4.4 GHz	1.152	23.02
45–920 MHz	1.036	35.05
920–2700 MHz	1.058	31
2700–3500 MHz	1.106	25.96
4400–5300 MHz	1.196	20.99
5300–6200 MHz	1.222	20.01
6200–8800 MHz	1.29	18

Mechanical Specifications

Attachment Durability	25 cycles
Connector Retention Tensile Force	889.64 N 200 lbf
Connector Retention Torque	5.42 N-m 47.998 in lb
Coupling Nut Proof Torque	4.52 N-m 39.997 in lb
Coupling Nut Retention Force	444.82 N 100 lbf
Coupling Nut Retention Force Method	MIL-C-39012C-3.25, 4.6.22
Interface Durability	500 cycles
Interface Durability Method	IEC 61169-16:9.5

Environmental Specifications

Attenuation, Ambient Temperature	20 °C 68 °F
Average Power, Ambient Temperature	40 °C 104 °F

Packaging and Weights

Weight, net	108.86 g 0.24 lb
--------------------	--------------------

Regulatory Compliance/Certifications

Agency	Classification
CHINA-ROHS	Below maximum concentration value
ISO 9001:2015	Designed, manufactured and/or distributed under this quality management system
ROHS	Compliant

L4PNM-H

UK-ROHS

Compliant



* Footnotes

Insertion Loss Coefficient, typical $0.05\sqrt{\text{freq}}$ (GHz) (not applicable for elliptical waveguide)

LDF4-50A



LDF4-50A, HELIAX® Low Density Foam Coaxial Cable, corrugated copper, 1/2 in, black PE jacket Halogen free jacketing non-fire-retardant (General propose cable for outdoor use only)

Product Classification

Product Type	Coaxial wireless cable
Product Brand	HELIAX®
Product Series	LDF4-50A
Ordering Note	ANDREW® standard product (Global)

General Specifications

Product Number	520094002/00 SZ520094902/00
Flexibility	Standard
Jacket Color	Black
Performance Note	Attenuation values typical, guaranteed within 5%

Dimensions

Diameter Over Dielectric	12.954 mm 0.51 in
Diameter Over Jacket	15.875 mm 0.625 in
Inner Conductor OD	4.826 mm 0.19 in
Outer Conductor OD	13.97 mm 0.55 in
Nominal Size	1/2 in

Electrical Specifications

Cable Impedance	50 ohm ±1 ohm
Capacitance	75.8 pF/m 23.104 pF/ft
dc Resistance, Inner Conductor	1.48 ohms/km 0.451 ohms/kft
dc Resistance, Outer Conductor	2.69 ohms/km 0.82 ohms/kft
dc Test Voltage	4000 V
Inductance	0.19 µH/m 0.058 µH/ft
Insulation Resistance	100000 MOhms-km
Jacket Spark Test Voltage (rms)	8000 V

LDF4-50A

Operating Frequency Band	1 – 8800 MHz
Peak Power	40 kW
Velocity	88 %

VSWR/Return Loss

Frequency Band	VSWR	Return Loss (dB)
680–800 MHz	1.13	24.3
800–960 MHz	1.13	24.3
1700–2200 MHz	1.13	24.3
2300–2700 MHz	1.13	24.3

Attenuation

Frequency (MHz)	Attenuation (dB/100 m)	Attenuation (dB/100 ft)	Average Power (kW)
1.0	0.211	0.064	36.11
1.5	0.259	0.079	29.46
2.0	0.299	0.091	25.5
10.0	0.672	0.205	11.35
20.0	0.954	0.291	7.99
30.0	1.172	0.357	6.51
50.0	1.521	0.463	5.02
85.0	1.995	0.608	3.82
88.0	2.031	0.619	3.76
100.0	2.169	0.661	3.52
108.0	2.256	0.688	3.38
150.0	2.673	0.815	2.85
174.0	2.887	0.88	2.64
200.0	3.103	0.946	2.46
204.0	3.135	0.956	2.43
300.0	3.835	1.169	1.99
400.0	4.462	1.36	1.71
450.0	4.749	1.447	1.61
460.0	4.804	1.464	1.59
500.0	5.021	1.53	1.52
512.0	5.085	1.55	1.5
600.0	5.533	1.686	1.38

LDF4-50A

700.0	6.009	1.831	1.27
800.0	6.456	1.968	1.18
824.0	6.56	1.999	1.16
894.0	6.855	2.089	1.11
960.0	7.124	2.171	1.07
1000.0	7.284	2.22	1.05
1218.0	8.11	2.472	0.94
1250.0	8.226	2.507	0.93
1500.0	9.093	2.771	0.84
1700.0	9.744	2.97	0.78
1794.0	10.039	3.06	0.76
1800.0	10.058	3.066	0.76
2000.0	10.666	3.251	0.72
2100.0	10.961	3.341	0.7
2200.0	11.251	3.429	0.68
2300.0	11.535	3.516	0.66
2500.0	12.09	3.685	0.63
2700.0	12.627	3.849	0.6
3000.0	13.407	4.086	0.57
3400.0	14.401	4.389	0.53
3600.0	14.882	4.536	0.51
3700.0	15.118	4.608	0.5
3800.0	15.353	4.679	0.5
3900.0	15.585	4.75	0.49
4000.0	15.815	4.82	0.48
4100.0	16.042	4.889	0.48
4200.0	16.268	4.958	0.47
4300.0	16.492	5.027	0.46
4400.0	16.714	5.094	0.46
4500.0	16.934	5.161	0.45
4600.0	17.153	5.228	0.44
4700.0	17.37	5.294	0.44
4800.0	17.585	5.36	0.43
4900.0	17.798	5.425	0.43
5000.0	18.01	5.489	0.42

LDF4-50A

6000.0	20.055	6.113	0.38
8000.0	23.826	7.262	0.32
8800.0	25.244	7.694	0.3

Material Specifications

Dielectric Material	Foam PE
Jacket Material	PE
Inner Conductor Material	Copper-clad aluminum wire
Outer Conductor Material	Corrugated copper

Mechanical Specifications

Minimum Bend Radius, multiple Bends	127 mm 5 in
Minimum Bend Radius, single Bend	50.8 mm 2 in
Number of Bends, minimum	15
Number of Bends, typical	50
Tensile Strength	113 kg 249.122 lb
Bending Moment	3.8 N-m 33.633 in lb
Flat Plate Crush Strength	2 kg/mm 111.995 lb/in

Environmental Specifications

Installation temperature	-40 °C to +60 °C (-40 °F to +140 °F)
Operating Temperature	-55 °C to +85 °C (-67 °F to +185 °F)
Storage Temperature	-70 °C to +85 °C (-94 °F to +185 °F)
Attenuation, Ambient Temperature	68 °F 20 °C
Average Power, Ambient Temperature	104 °F 40 °C
Average Power, Inner Conductor Temperature	212 °F 100 °C

Packaging and Weights

Cable weight	0.22 kg/m 0.148 lb/ft
---------------------	-------------------------

Regulatory Compliance/Certifications

Agency	Classification
CENELEC	EN 50575 compliant, Declaration of Performance (DoP) available
CHINA-ROHS	Below maximum concentration value
ISO 9001:2015	Designed, manufactured and/or distributed under this quality management system

LDF4-50A

REACH-SVHC

Compliant as per SVHC revision on www.andrew.com/ProductCompliance

ROHS

Compliant

UK-ROHS

Compliant

