

TC-10724P

Rev A, Mar 2017

www.commscope.com

15 inch GPS3 series

1 General

The 15" generic tray patching & splicing shelf FIST-GPS3 is a high density mechanical assembly for the fiber management system that provides the function of cable splicing and patch cord patching and connecting in a rack environment. This shelf can be used with 15" TE connectivity racks.

High density

- 48 SC*/96 LC adapters in 2HU shelf
- 72 SC*/144 LC adapters in 3HU shelf
- 96 SC*/192 LC adapters in 4HU shelf
- *E2000 adapters are also possible if selected adapters and specific boot lengths are used.

Flexibility

- Proven splicing concept with bend radius protection and solutions for G652 and G657 fibers and splice protectors (heat shrink SMOUV or mechanical protection ANT)
- Compatible with TE Connectivity's GR3F rack .

2 Kit content



1 metal shelf incorporating:

- Hinge and fastening strap strap for installation of GPSTF-12 trays
- Cage nuts and bolts
- Installation instructions
- Tie wraps and foam tap
- 1x Edge protection
- 2x Pigtail trumpets
- Standard mounting bracket

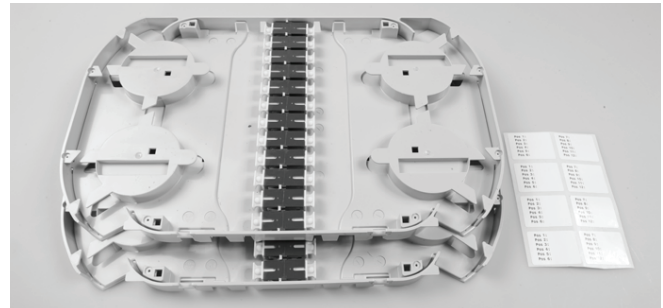

GPSTF-12 trays configuration: Patch only

- Tray with 2x patch islands
- Always delivered in sets of 2 complementary pieces
- Empty or 12 adapters
- Labels

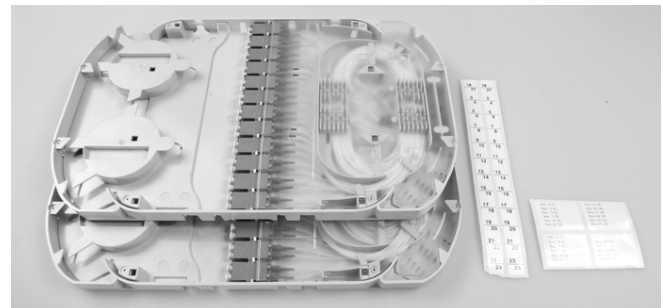

GPSTF-12 trays configuration: Patch/Splice
(Loose tube and preconnectorized IFC cable)

- Tray with 1x patch island and 1x splice island including a splice holder for 12 splices or 2x splice holder in case of duplex LC adapters (24 splices).
- 12 connector adapters and pigtails per tray /24 in case of duplex LC (No pigtails in case of IFC)
- Always delivered in sets of 2 complementary pieces.
- Labels

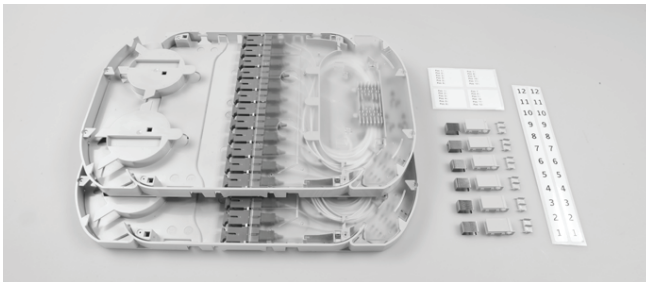

GPSTF-12 trays configuration: patch/splice
(Loose tube and preconnectorized IFC cable)

- Tray with 1x patch island and 1x splice island including a splice holder for 12 splices or 2x splice holder in case of duplex LC adapters (24 splices).
- 12 connector adapters and pigtails per tray /24 in case of duplex LC (No pigtails in case of IFC)
- Always delivered in sets of 2 complementary pieces.
- Labels

3 Optional Tools

- FACC-ALLEN-KEY-5-350 To mount the shelf in the rack
- FACC-CAGE-NUT-TOOL For easy installation of cage nuts in the rack

4 Installation of the shelf



4.1 Fix the first cage nuts into the rack profile using the CAGE-NUT-TOOL.

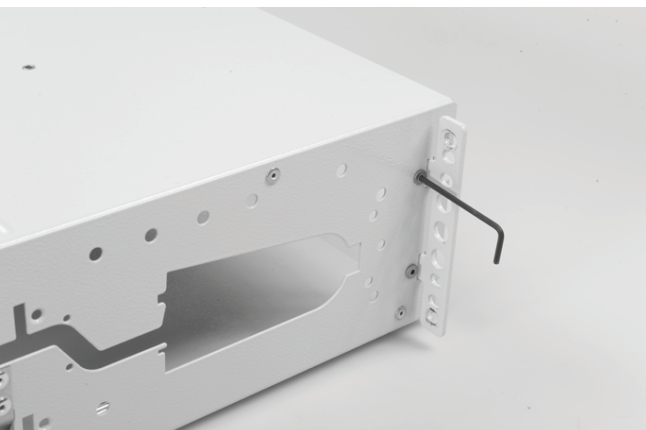

4.2 Fix the first cage nuts into the rack profile using the CAGE-NUT-TOOL

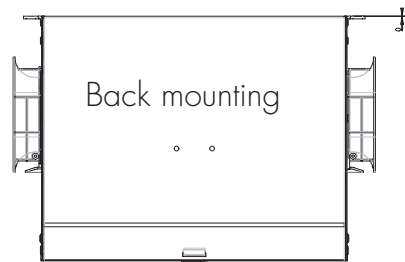
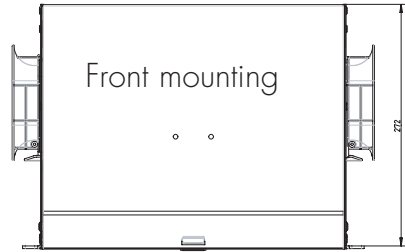
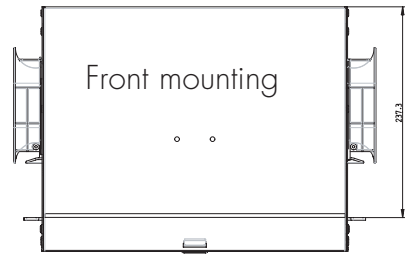

4.3 Different mounting positions.



4.4 Mount the shelf in the mounted cage nuts using the ALLEN-KEY-5-350.

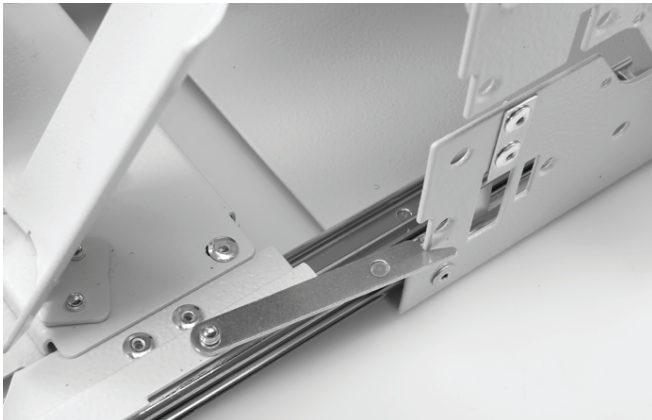

4.5 Pull the drawer to fully open position and rotate the security-lip 180° to prevent the drawer from moving back inside the unit.

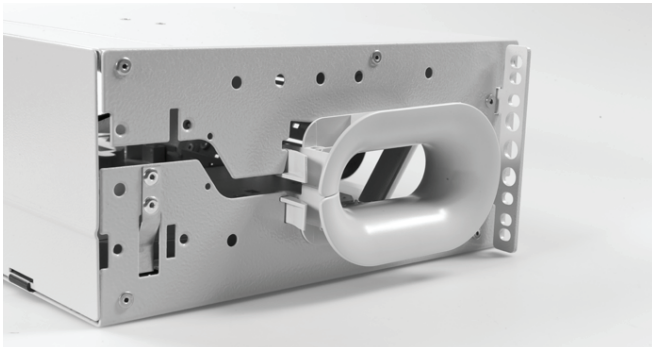
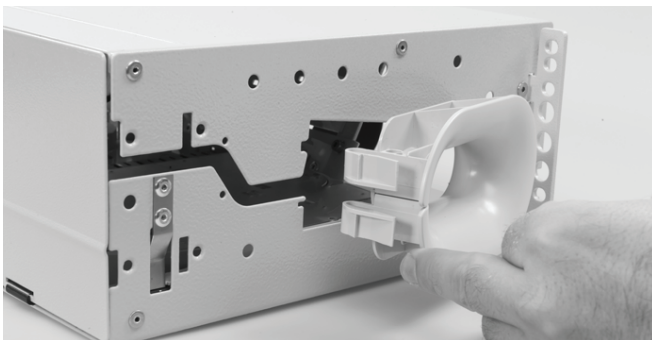

4.6 A trumpet is needed at the side where the pigtails are entering the shelf. Slide-click the trumpet in the side panel.

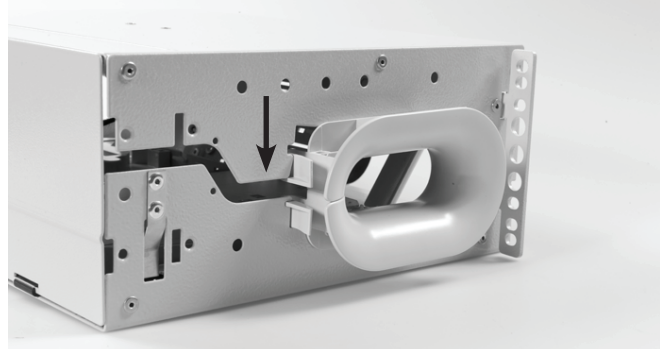
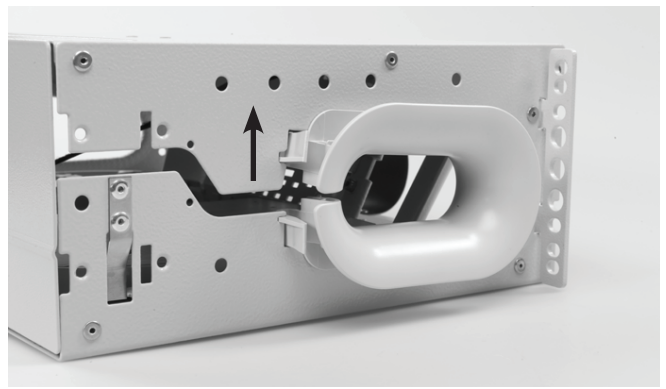

4.7 The trumpet can be opened and closed in case pigtails are installed via the front.



4.8 Install the edge protector on the entrance cable area side.

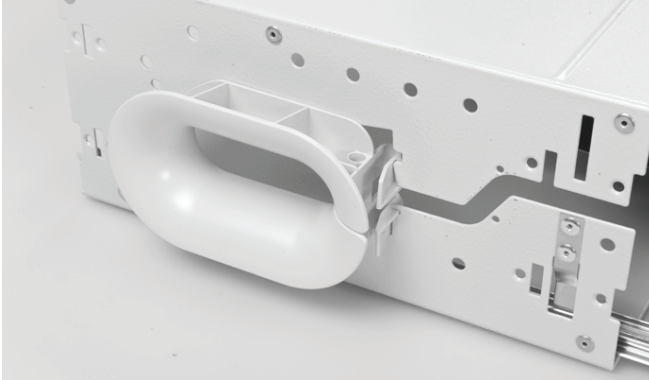
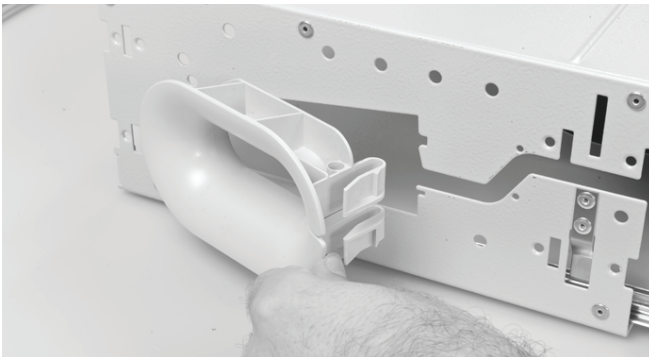

4.9 Install the other pigtail trumpet in case of a patch-patch configuration. Follow the steps in point 3.6 to guide the patch cords in.

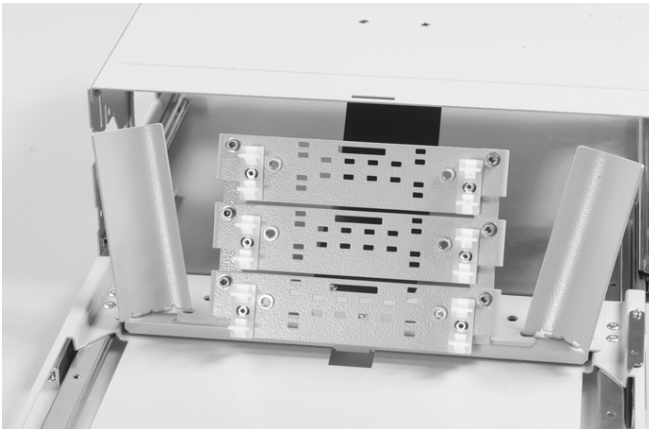

4.10 Take all trays out of the shelf.

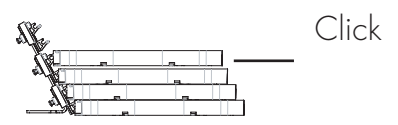
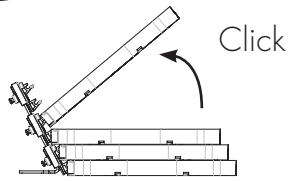
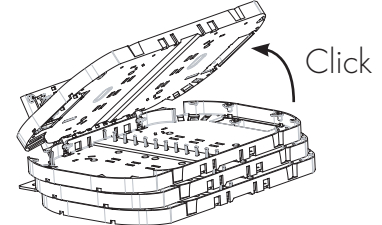
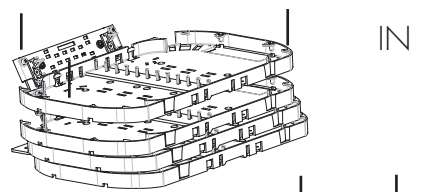
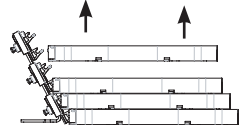
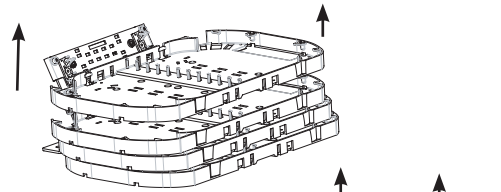
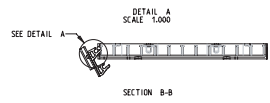
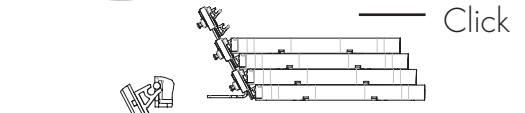
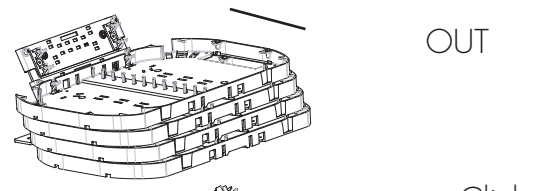

4.11 All trays can easily be inserted or removed.

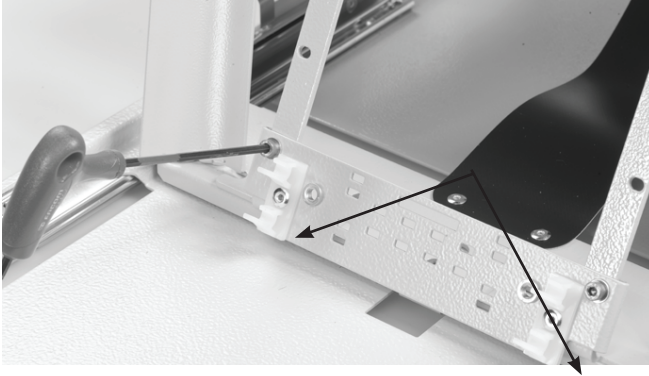
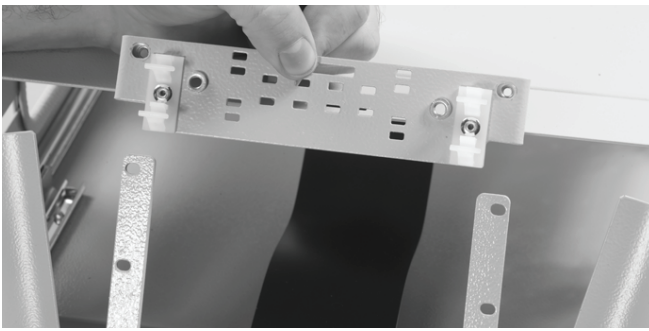

4.12 In case of 2HU all hinge brackets need to be installed first. Slide the bracket over the two metal hinges and secure it using screws and washers.

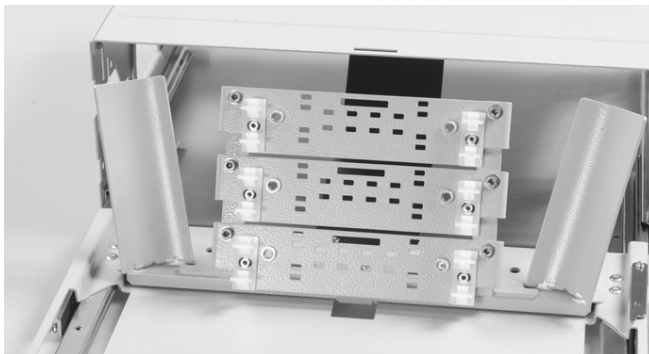

4.13 Repeat it until all brackets are installed.

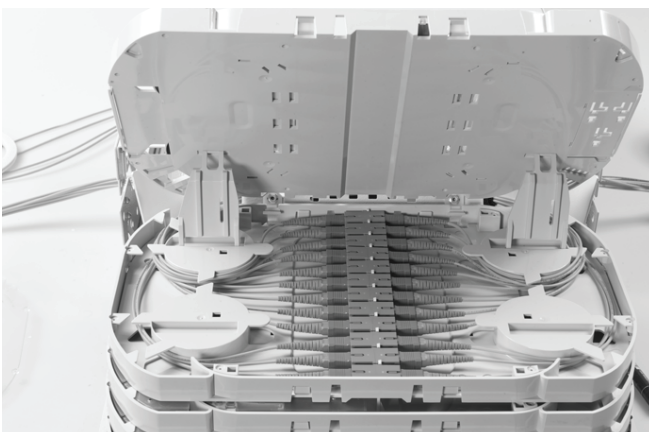

3.14 To make a tray accessible lift all the trays above it. Keep them in position by using two tray wedges.

5 Cable termination

5.1 Cable termination in the rack

A cable is already terminated inside the rack or inside the side duct of the rack on the cable attachment plate. For the loose tube cable, the tubes are protected from the cable attachment plate with the flex tube.

A Loose tube cable (single fiber)

5.1.1 Cut a flex tube to length according the cable position inside the rack and remove the cable jacket according this length. Make sure you have 2 m of loose tube inside the shelf.



5.1.2 Apply four times a foam tape around the end of the flex tube.



5.1.3 Also apply foam tape around the flex tube approximately 38 cm from the end of the flex tube.

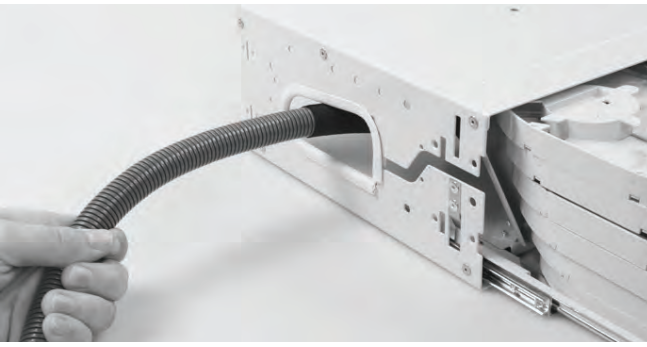

5.1.4 Apply foam tape around the flex tube approximately 38 cm from the end of the flex tube.

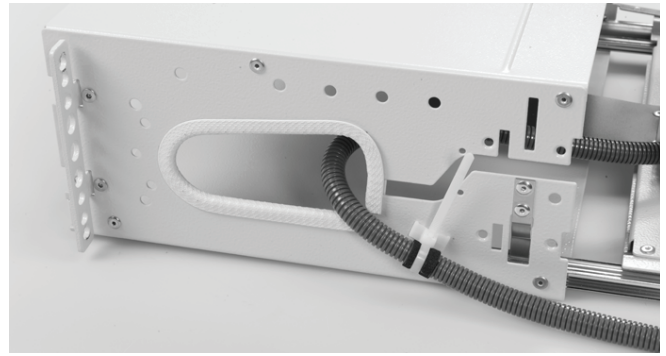

5.1.7 Plug the tie wrap into the hole next to the side cable entrance. Secure the outgoing flex tube over the foam tape using tie-wrap.

NOTE: Use this set up only for the bottom side cable entrance into the rack

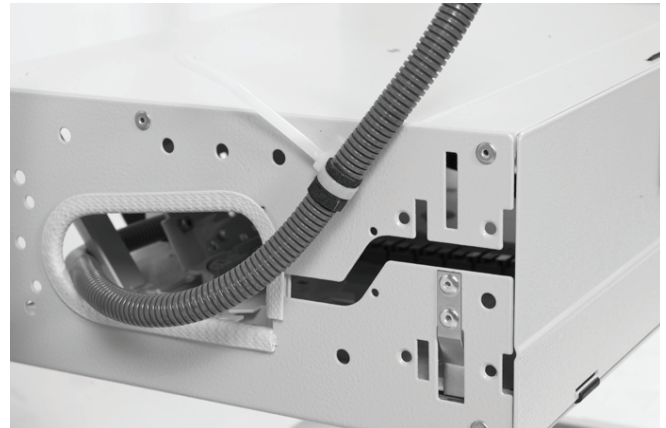
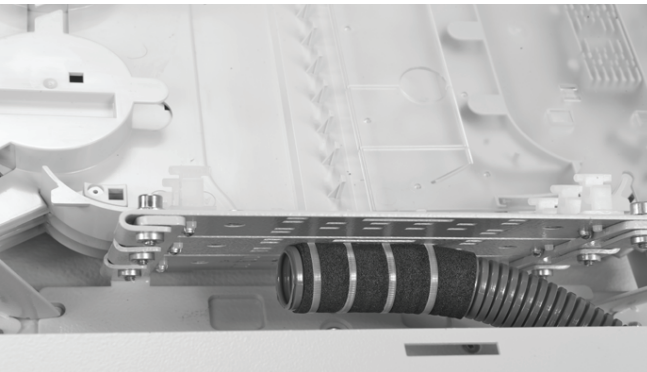

5.1.8 Plug the tie-wrap into the hole next to the side cable entrance. Secure the outgoing flex tube over the foam tape using tie-wrap.

NOTE: Use this set up only for the top side cable entrance into the rack.

5.1.5 Make sure the flex tube is long enough for the drawer to slide easily in and out. Secure the flex tube using **four** tie wraps over the foam as shown on the pictures.

B Cable termination in the shelf



5.1.6 The knobs of the tie wraps must be positioned at the front of the metal hinge plate.

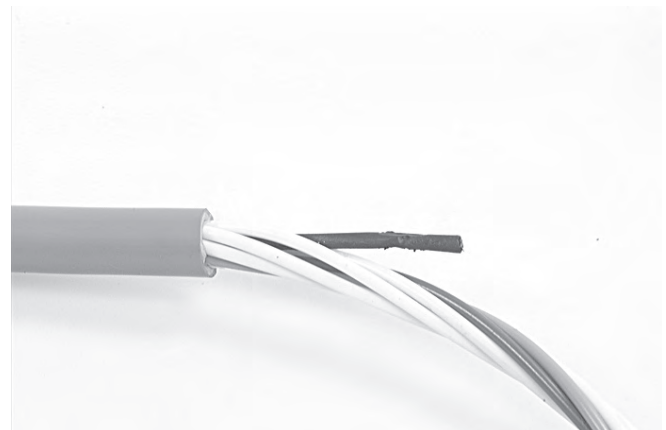

5.1.9 Remove the cable jacket over approximately 1.2 m. Wait to strip the loose tube to avoid fiber breakage. Cut the strength member to length ($l = \text{max. } 35 \text{ mm}$) and fasten the strength member connector with the Allen key.

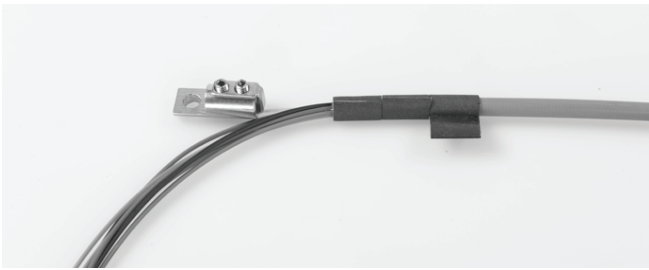

5.1.10 Apply three times a foam tape around the end of the cable.



5.1.11 Also apply foam tape around the cable approximately 38cm from the point where cable is stripped.

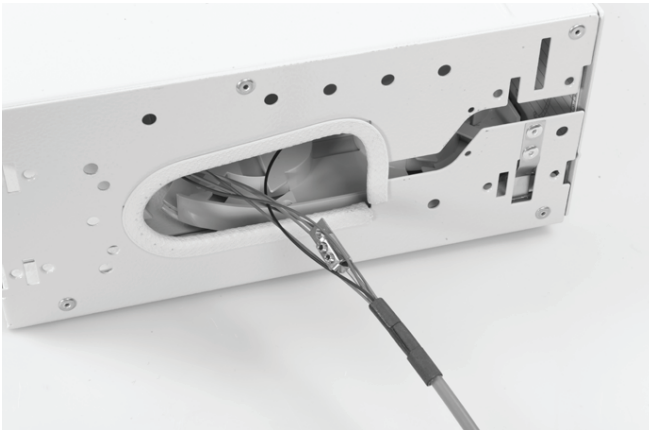

5.1.12 Feed the cable gently through the side entrance of the shelf.

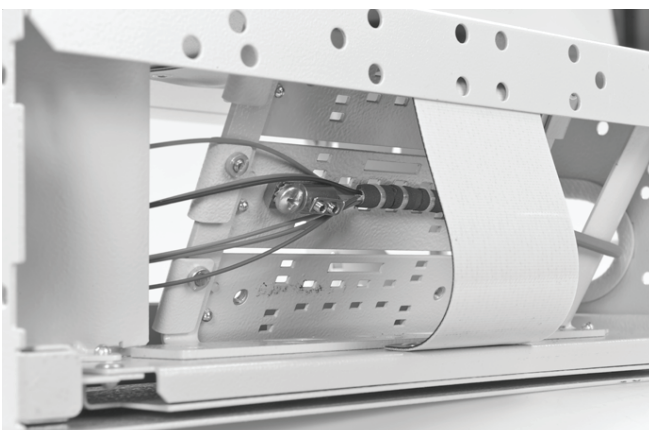

5.1.13 Fasten the strength member connector. Avoid unnecessary crossing of strength member and loose tube. Secure the flex tube using **three** tie wrap over the foam as shown on the pictures.

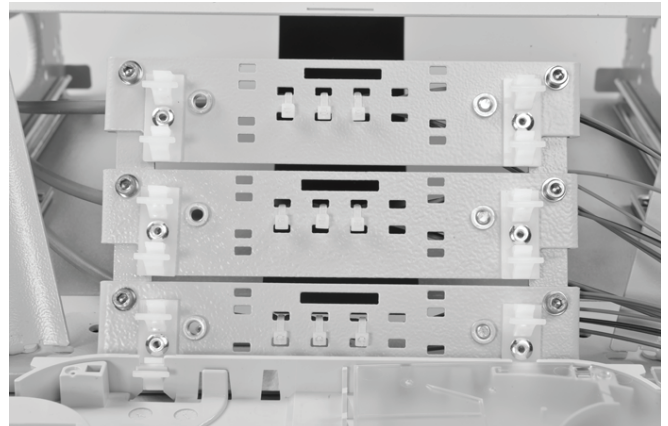

5.1.14 The knobs of the tie wrap must be positioned at the front of the metal hinge plate.

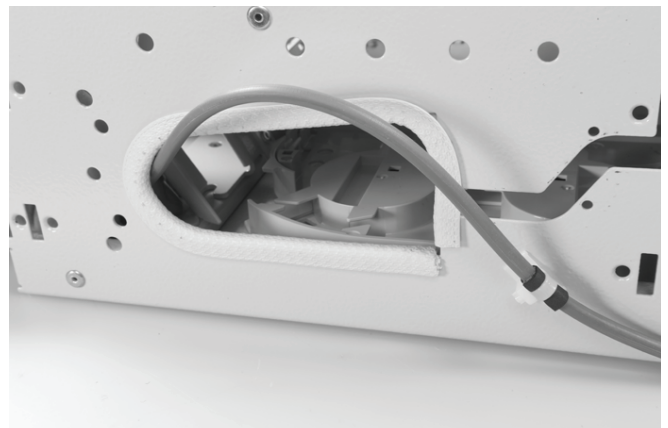

5.1.15 Plug the tie-wrap into the hole next to the side cable entrance. Secure the outgoing flex tube over the foam tape using tie-wrap.
NOTE: Use this set up only for bottom side cable entrance into the rack.

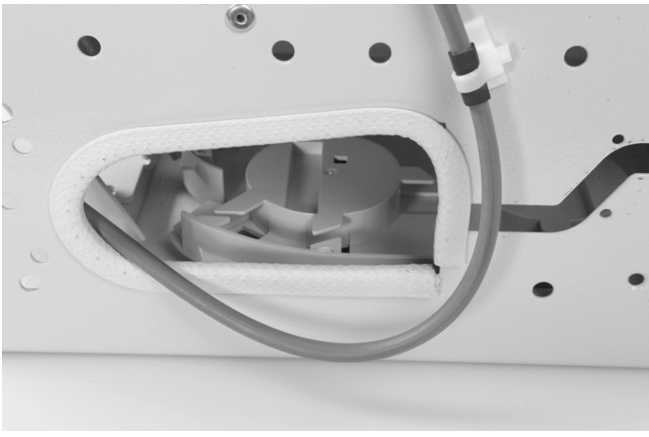

5.1.16 Plug the tie-wrap into the hole next to the side cable entrance. Secure the outgoing flex tube over the foam tape using tie-wrap.

NOTE: Use this set up only for the top side cable entrance into the rack.

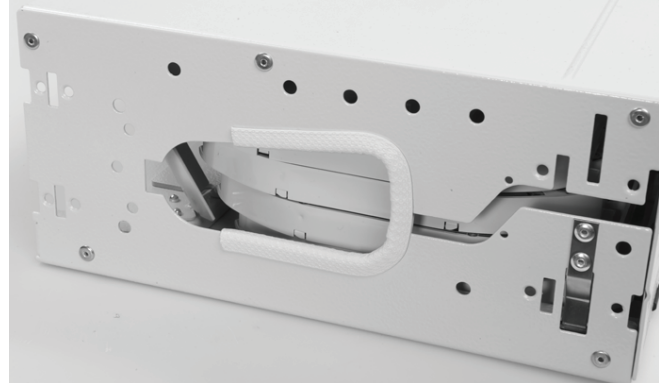
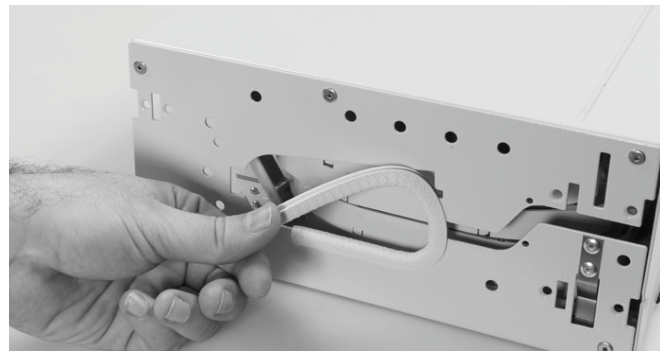

5.2 Side cable termination directly on the shelf

4.3.1 The cable can be terminated on the shelf: cable terminations are suited for max. 2 cables, cable retention with tie wrap, the loose tubes are fed through a flexible tube to the shelf, the strength member is attached to the plate.

A Loose tube cable

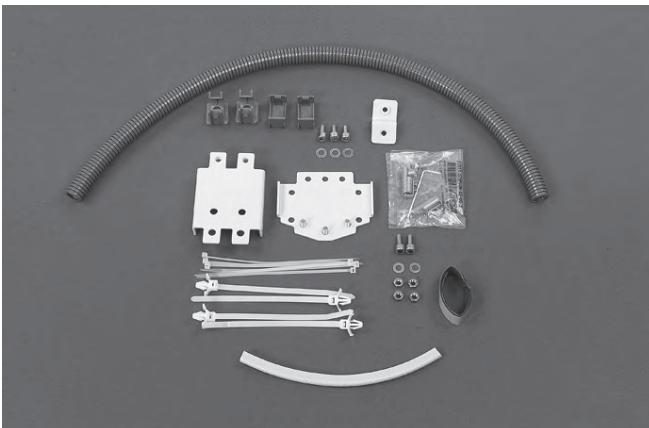

Kit contents

- 2 metal plates
- 2 strength member connectors + screws
- 1 flexible tube (predefined length)
- 3 bolts and nuts
- 4 releasable tie wrap
- 2 tube clips + lid
- 1 edge protection
- 1 foam strip
- 2 tie wrap
- 1 tube holder bracket

5.2.1 Install the small edge protector (from the kit) on the side entrance cable area for patch-splice configuration.

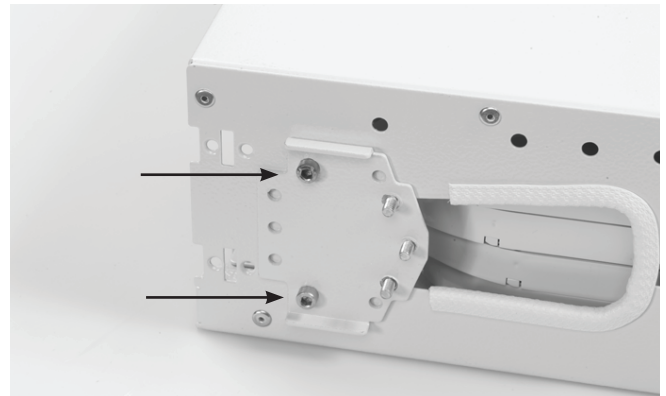

5.2.2 Install the main bracket plate using two screws with washers and nuts from the inside.

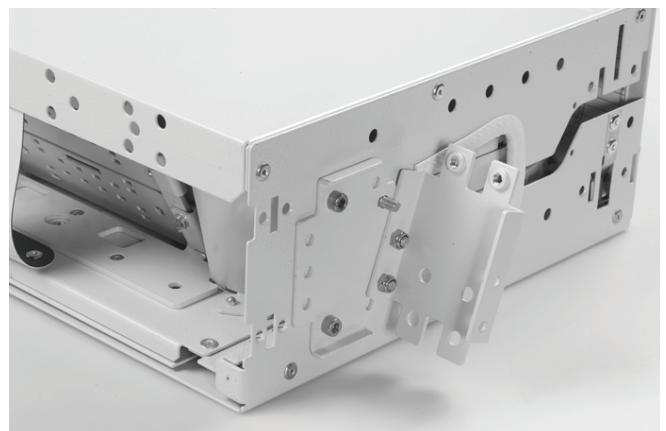

5.2.3 Assemble the other metal bracket as shown for the left side mounting and cables coming from the bottom.

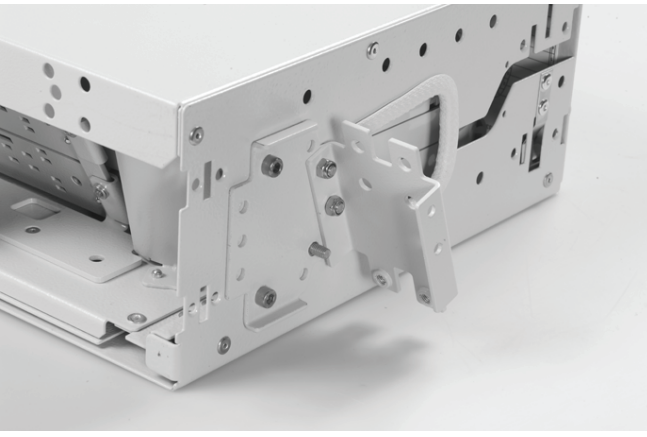

5.2.4 Assemble the other metal bracket as shown for the left side mounting and cables coming from the bottom.

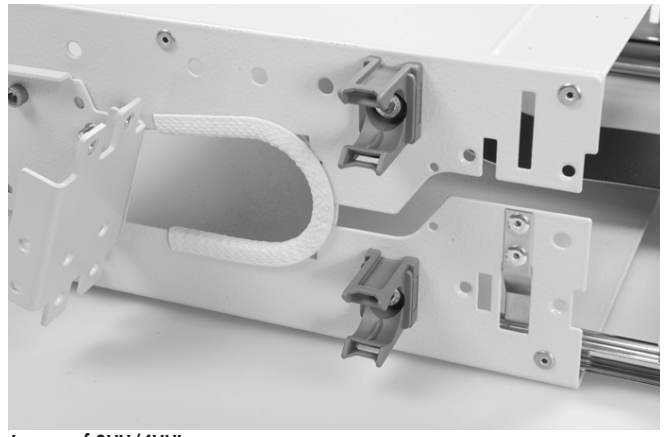

In case of 3HU/4HU1

5.2.6 Install both flex tube holders on the shelf.



5.2.5 For 2HU only: install the flex tube holder on the bracket.



5.2.7 Install both flex tube holders on the shelf.



In case of 2HU – bottom holder using bracket

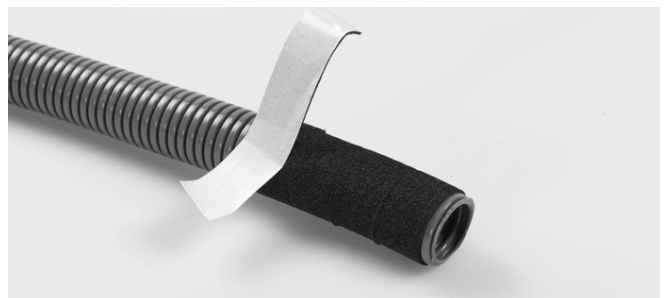

5.2.8 Apply four times a foam tape around the end of the flex tube.

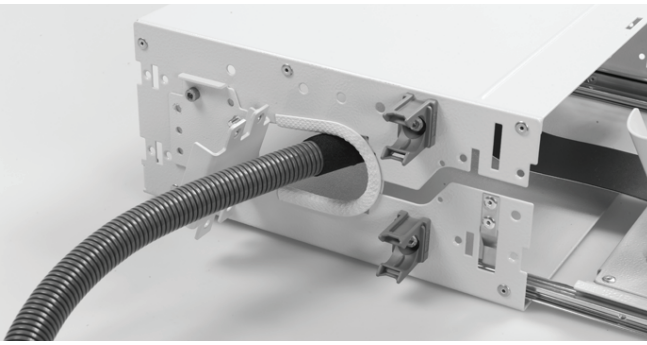

5.2.9 Feed the flex tube through the side entrance of the shelf.

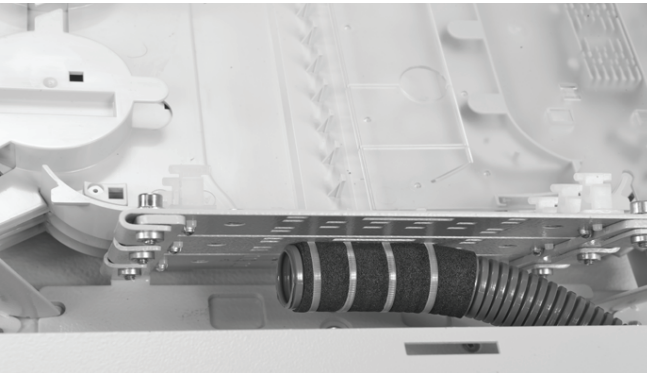

5.2.10 Make sure the flex tube is long enough for the drawer to slide easily in and out. Secure the flex tube using **four** tie wrap and foam as shown on the pictures.



5.2.11 The knobs of the tie wrap must be positioned at the front of the metal hinge plate.

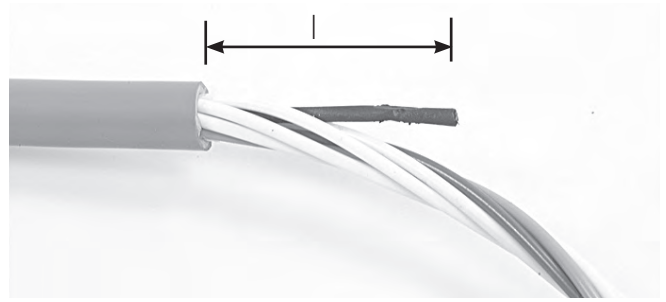

5.2.12 Remove the cable jacket over approximately 2.2 m. Wait to strip the loose tube to avoid fiber breakage. Cut the strength member to length ($l = \text{max. } 35 \text{ mm}$) and fasten the strength member connector with the Allen key.

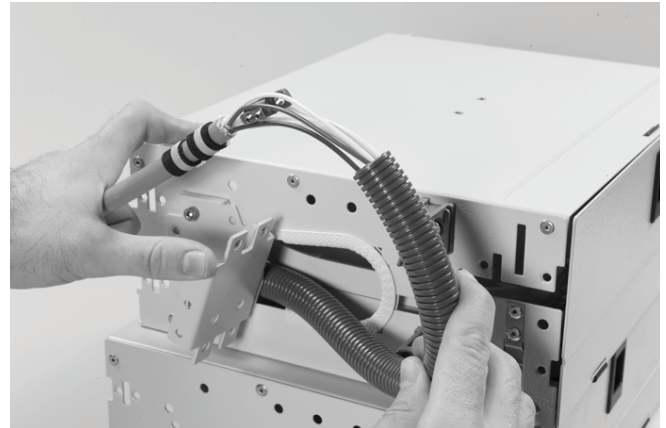

5.2.13 Remove the cable jacket over approximately 2.2 m. Wait to strip the loose tube to avoid fiber breakage. Cut the strength member to length ($l = \text{max. } 35 \text{ mm}$) and fasten the strength member connector with the Allen key.

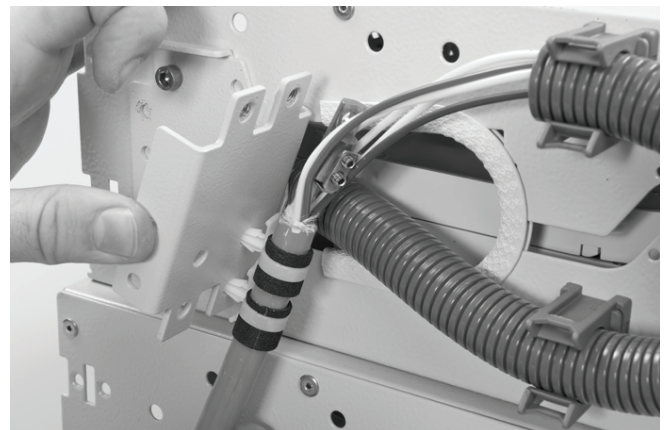

5.2.14 First fasten the flex tube at the bottom tube holder and afterwards at the top tube holder.

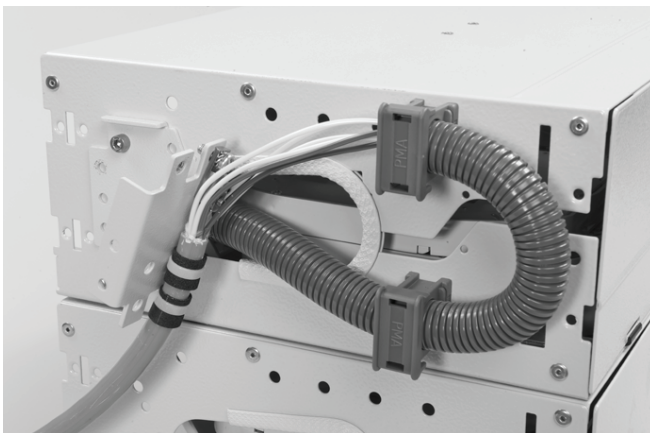

5.2.15 Fasten the strength member connector. Avoid unnecessary crossing of strength member and loose tube. Attach the cable with the releasable tie wraps. Mount the cover on the flex tube holder.

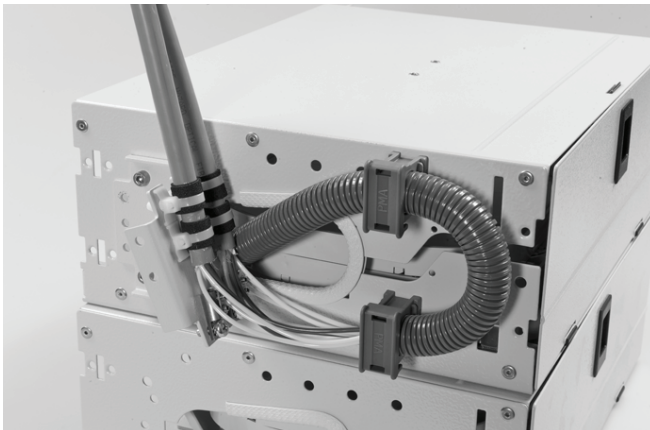

5.2.16 For cables coming from the top, use a reverse assembly.

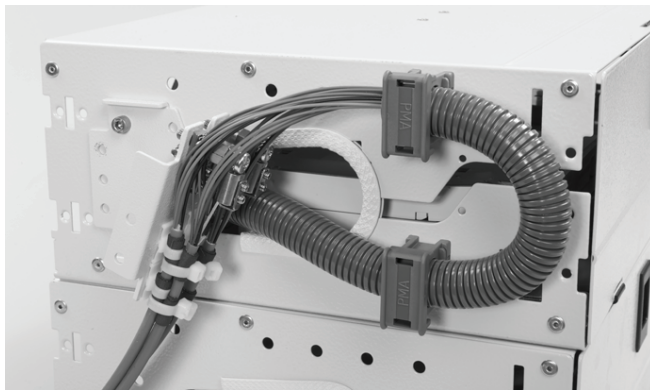

5.2.17 Up to 4 cables can be used. Attach them together using tie wrap.

B IFC Cable/break-out cable

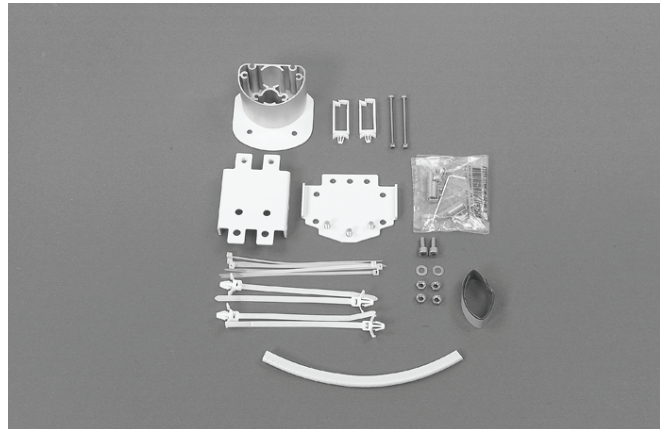

Kit contents

- 2 metal plates
- 2 strength member connectors + screws
- 1 drum
- 3 bolts and nuts
- 4 releasable tie wrap
- 1 edge protection
- 1 foam strip
- 2 tie wrap
- 2 clips

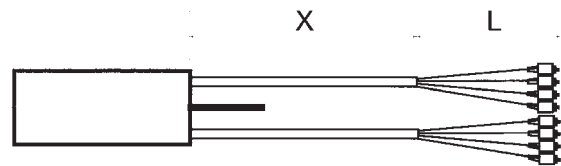

5.2.18 Kit contents In case of IFC: remove $X = 800$ mm of outer jacket. The recommended length of secondary fiber $L = 1250-1500$ mm. In case of break-out cable: remove $X+L = \text{max. } 2,3$ m of outer jacket.



5.2.19 Install the edge protection at the bottom of the opening. Mount the drum on the side panel. Cut the strength member to 35 mm maximum. Attach the strength member and install as shown. Same installation and routing for break-out cable. Recommended to use GTU (see section 5.2).

5.3 Back cable termination directly on the shelf

5.3.1 Cable terminations are suited for 2 cables, max. 3, cable retention with tie wrap. Loose tubes are fed through a flexible tube to the shelf, the strength member is attached to the plate. In case of IFC no flex tube is used (see point 4.3.10).

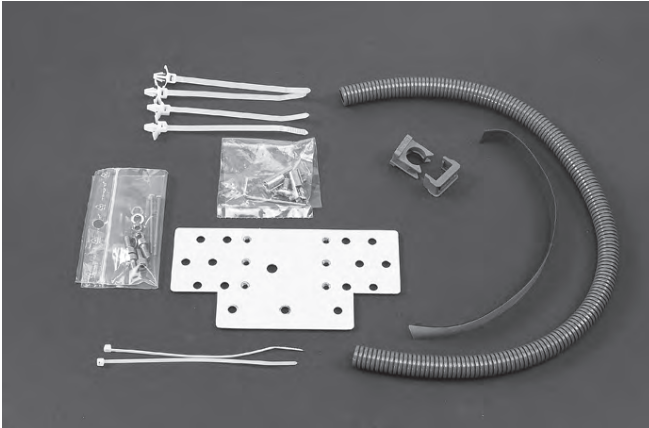

Kit contents

- 2 metal plates
- 2 strength member connectors + screws
- 1 drum
- 3 bolts and nuts
- 4 releasable tie wrap
- 1 edge protection
- 1 foam strip
- 2 tie wrap
- 2 clips

A Loose tube cable

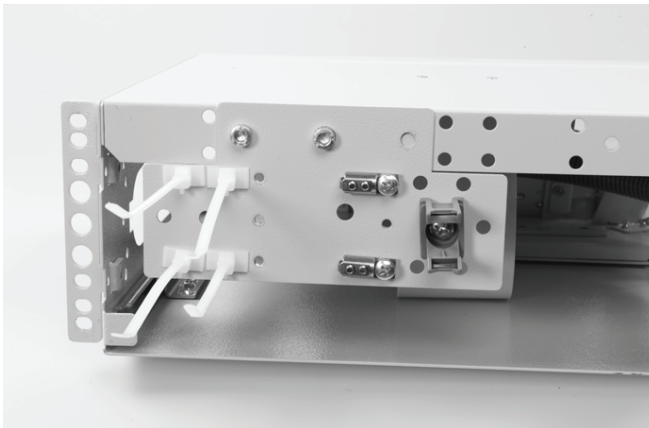

5.3.2 Attach the components to the termination plate. The picture shows a cable coming from the left (seen from the back). For cable coming from right the reverse assembly is required. X = 80 mm.

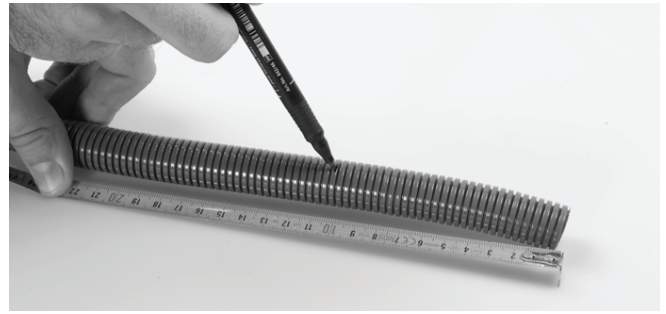

5.3.3 Cut 20 cm out of the flex tube.

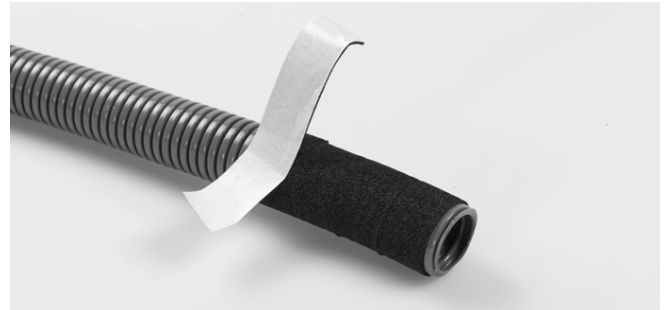

5.3.4 Apply four times a foam tape around the end of the flex tube.

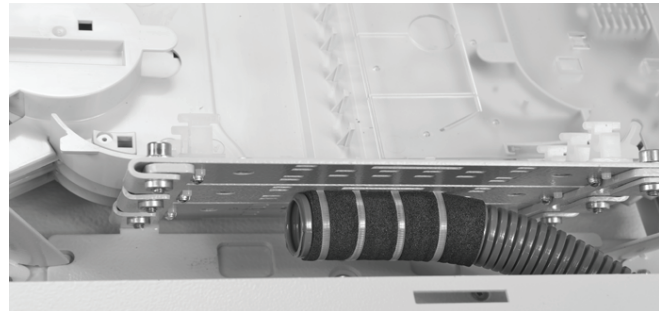

5.3.5 Make sure the flex tube is long enough for the drawer slide easily in and out. Secure the flex tube using **four** tie wrap and foam as shown on the pictures.



5.3.6 The knobs of the tie wrap must be positioned at the front of the metal hinge plate.

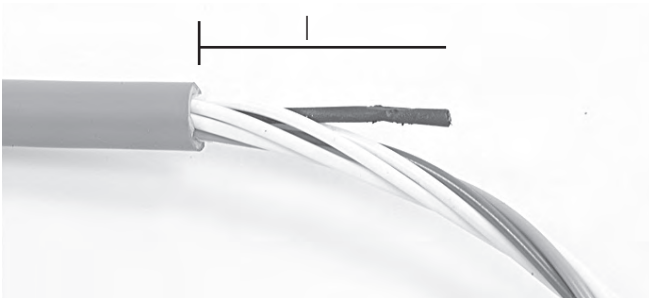

5.3.7 Remove the cable jacket over approximately 2 m. Wait to strip the loose tube to avoid fiber breakage. Cut the strength member to length ($L = \text{max. } 60 \text{ mm}$) and fasten the strength member connector with the Allen key.

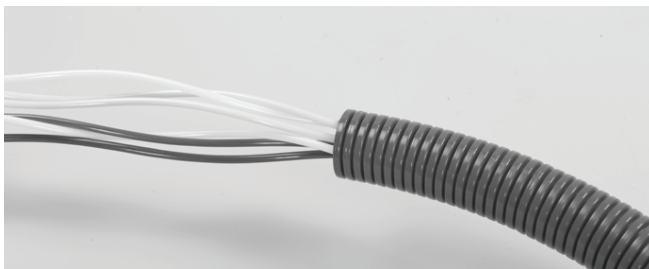

5.3.8 Guide the identified loose tubes into the flex tube. This can be facilitated by keeping the end of the loose tubes bundled together with a piece of tape. Make a loop with the flexible tube behind the shelf and fix the flex tube into the clip of the termination plate.

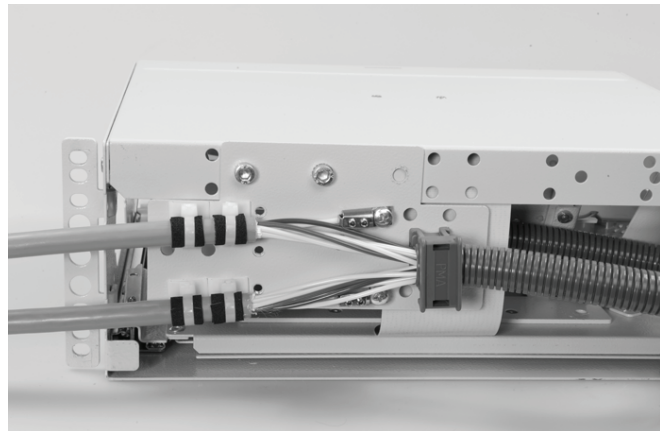
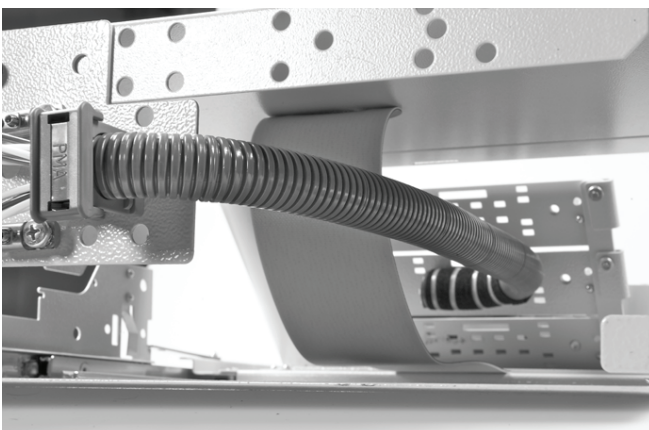

5.3.9 Attach the strength member connector to the back termination plate. Avoid unnecessary crossing of strength member and loose buffer tubes. Attach the cable with the releasable tie wraps on the outer jacket. Mount the cover on the flex tube holder.

B IFC cable/break-out cable

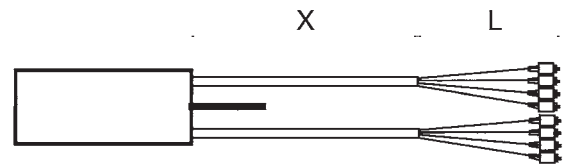

5.3.10 In case of IFC: remove $X = 700 \text{ mm}$ of outer jacket. The recommended length of secondary fiber $L = 1250\text{-}1500 \text{ mm}$.

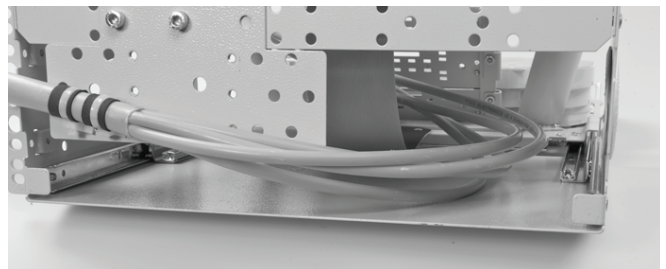

5.3.11 Cut the strength member at $L = 60 \text{ mm}$ maximum. Attach the strength member fixation and install as shown.

6 Fiber routing

6.1 Loose tube installation on the tray



6.1.1 Identify the loose tubes and put the tie wraps in position on the tray as shown.

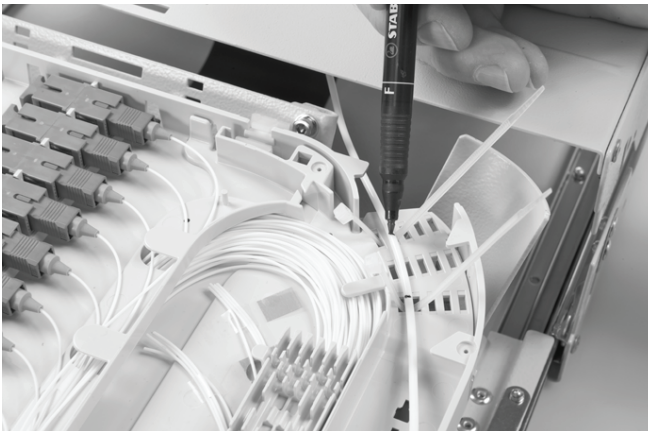

6.1.2 Bring the loose tubes on the tray and mark them where the tie wraps are located.



6.1.3 Put foam tape around the loose tube in the marked positions.

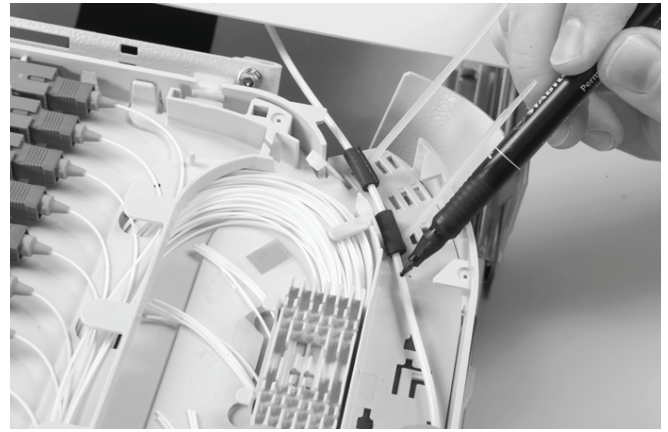

6.1.4 Push the loose tubes in the tray and mark them again 15 mm beyond the second tie wrap.



6.1.5 Strip the loose tubes at this second mark, clean the fibers and tighten the tie wrap. Make sure the tie wrap knob is at the side of the tube.



6.1.6 If loose tubes are added at a later date, use other positions.

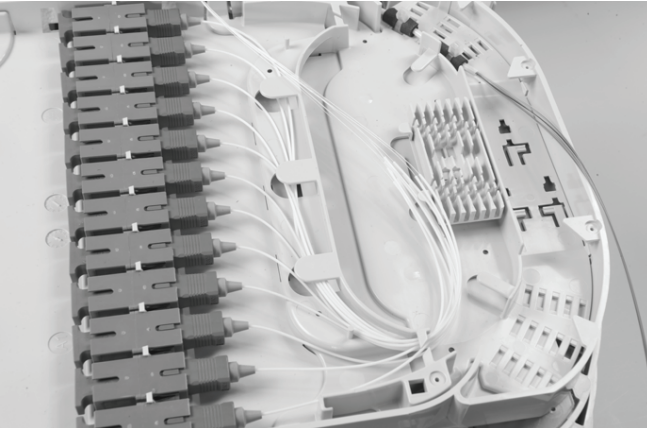
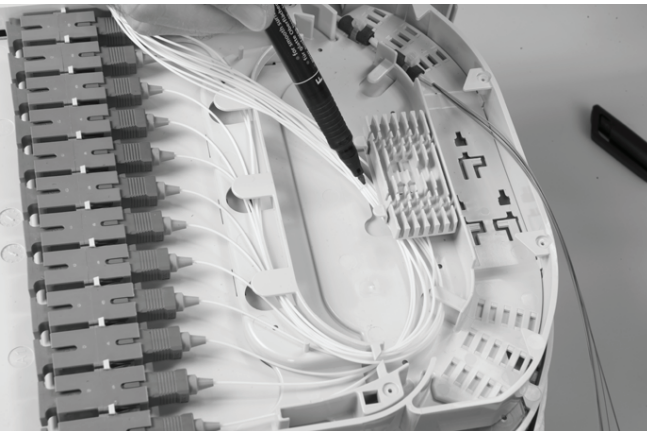

6.1.7 If applicable remove all pre-mounted pigtails from the storage area and mark the fibers at the splice holder. Remove the secondary coating from this point.

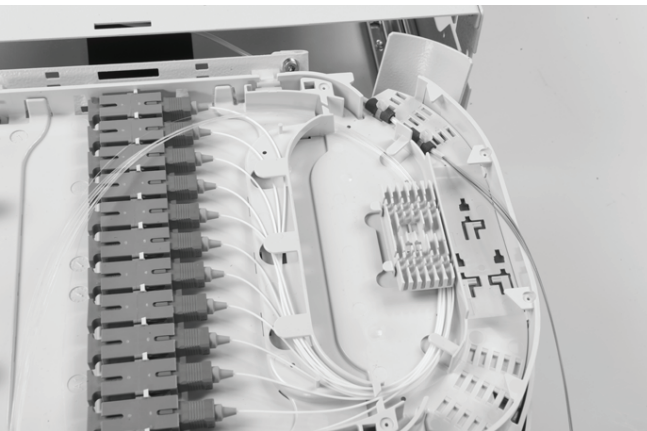

6.1.8 Position all the pigtails under the splice protection and leave them there. The fibers have to be kept in this position during further installation.

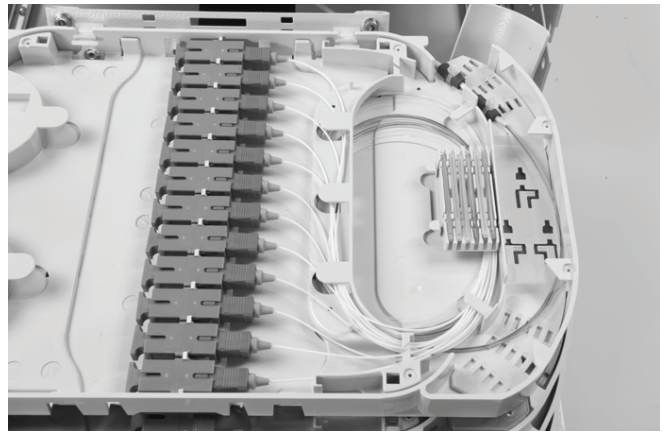

6.1.9 Place the splice protector in the holder, route the fibers, starting on the outside of the tray (hold the splice holder with your finger to prevent bending) and coil the fibers in the tray.

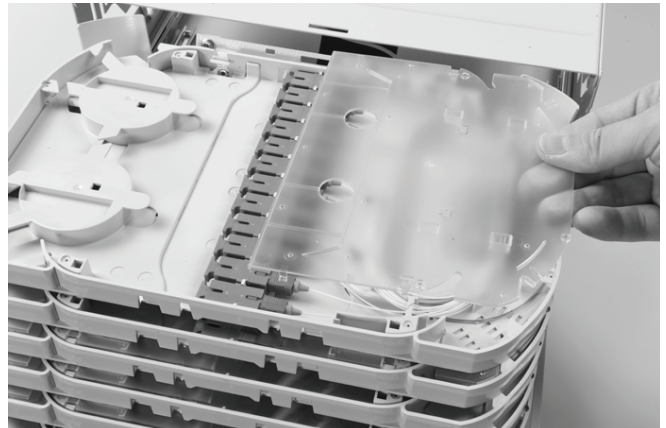

6.1.10 Check whether all fibers are properly routed before placing the cover on the tray. All fibers should be under the containment lips.

6.2 Break-out cable installation on the tray

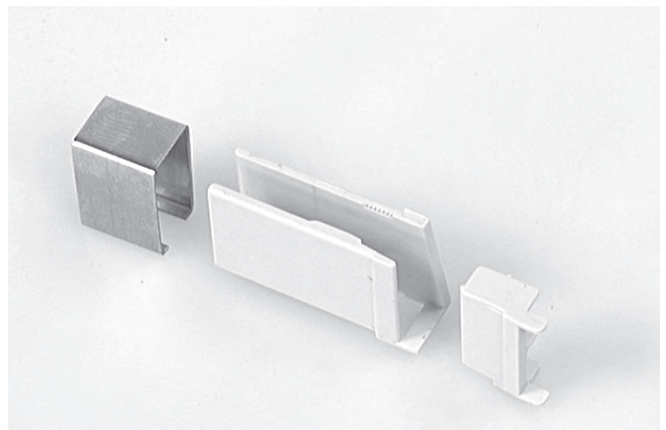

6.2.1 Use the GTU kit for the termination of a group of 4 pigtails.



6.2.2 Identify the 4 pigtails. Bundle them with PVC tape. Route them up to the tray, mark the 4 pigtails on the GTU position. Make sure there is 1.5 m pigtail available from this point. The length is limited to 1 m in case of a tight coated pigtail.



6.2.3 Strip the pigtail jacket at the marks. Cut the aramid strength member to ± 10 cm.

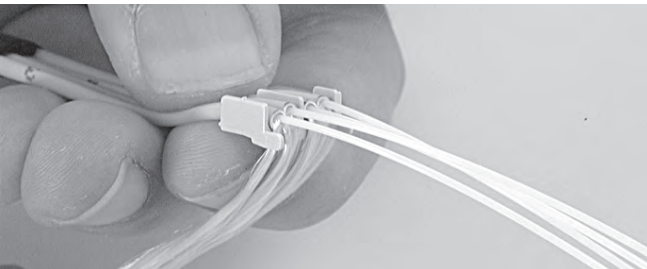

6.2.4 Bend the aramid yarns over the edge of the inner part. Don't entangle the fibers, avoid crossings.



6.2.5 Slide the outer part over the inner part. Keep both parts under a certain angle as shown. Keep the aramid yarns in position with your left thumb.

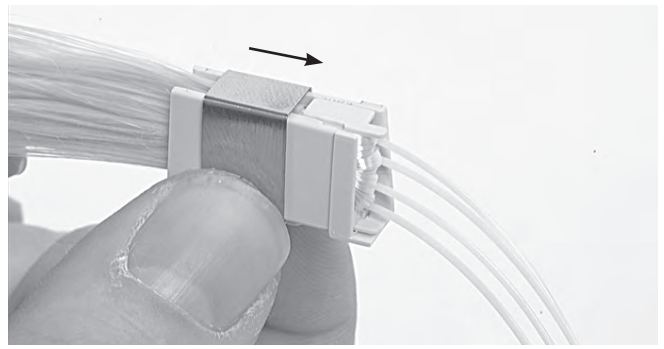

6.2.6 Slide the metal clip over the pigtails and then over the GTU, up to the front.

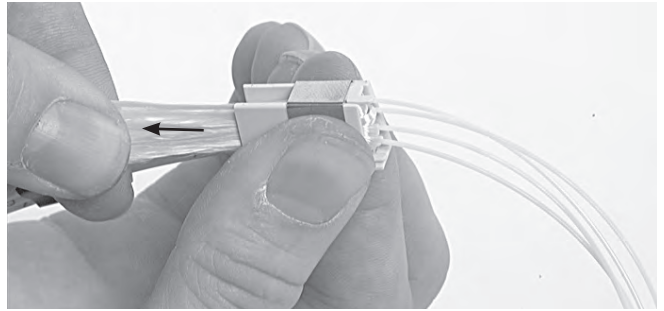

6.2.7 Take the GTU at the metal clip and pull at the aramid yarns until it locks completely.

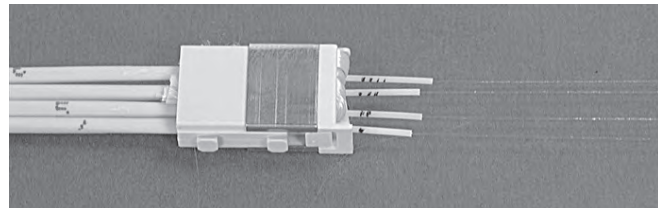

6.2.8 Cut excess aramid strength member. Identify the pigtails – use a marker and make dots as shown. Remove the secondary coating 10-20 mm from the GTU (only possible in case of a semi-tight pigtail).



6.2.9 In case of pigtails with a limited amount of (typical outside diameter < 2.4 mm): wrap the aramid strength member twice around the inner part. Bring the aramid strength member of 2 neighbouring pigtails together and pass the aramid strength member between both pigtails. Repeat for the 2 other pigtails. Always install 4 pigtails.

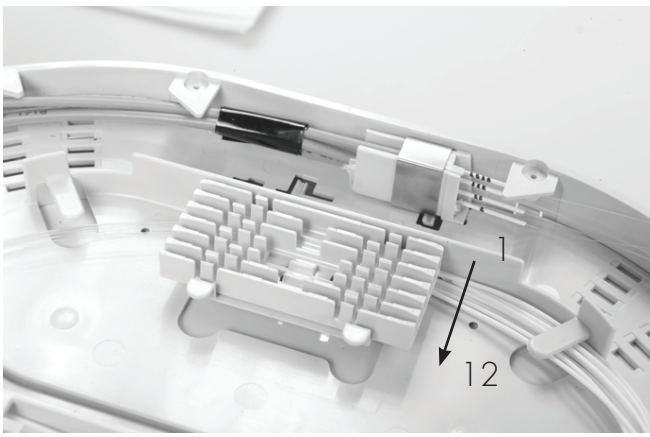

6.2.10 Mount the GTU. Start at on the outside of the tray.

6.2.11 Strip the pre-mounted pigtails (see 5.1.7-5.1.8).

6.2.12 Splice the fibers. Place the splice protector in his holder, start on the outside of the tray. (Hold the splice holder with your finger to prevent bending). Coil the fibers in the tray.

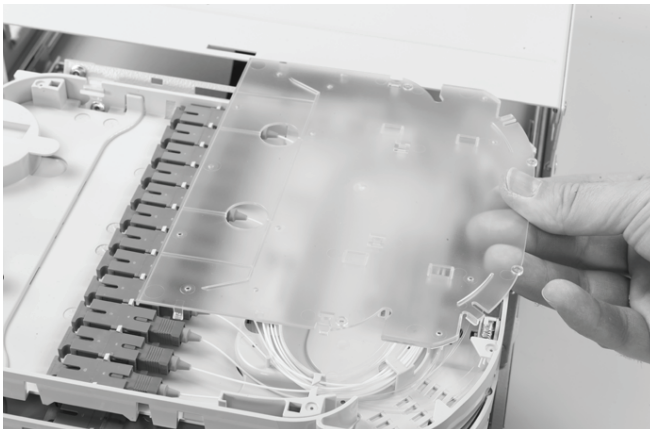

6.2.13 Check whether all fibers are properly routed before placing the cover on the module. Fibers cannot be on top of containment lips.

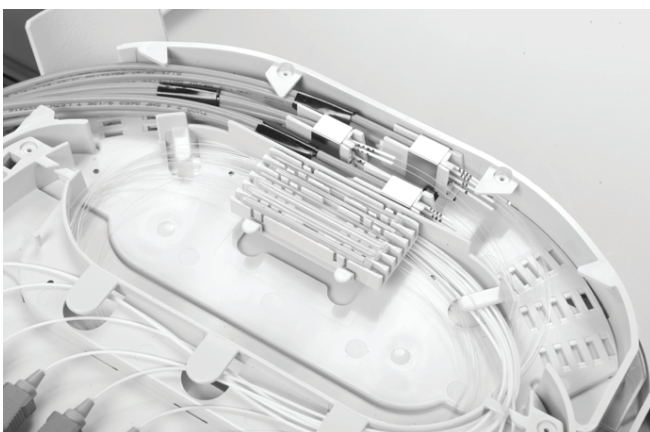

6.2.14 **Remark: storing non spliced fibers.**

When not all 12 fibers are spliced at once: route the non-spliced fibers on top of the stored fibers. Route them outside the storage zone to have easy access at a later date, without disturbing active circuits.

6.3 IFC cable installation on the tray



6.3.1 For ease of installation start with the bottom tray. If possible apply 1 wrap of foam tape around the IFC, just before the jacket end (This foam prevents easy pull-out and provides protection to the fibers inside). Attach the IFC to the tray with 2 small tie wrap. At least 1 tie-wrap should be on top of the foam tape. Cut the excess length of the tie-wrap. Make sure the tie wrap knob is at the side of the IFC. Don't squeeze the fibers.

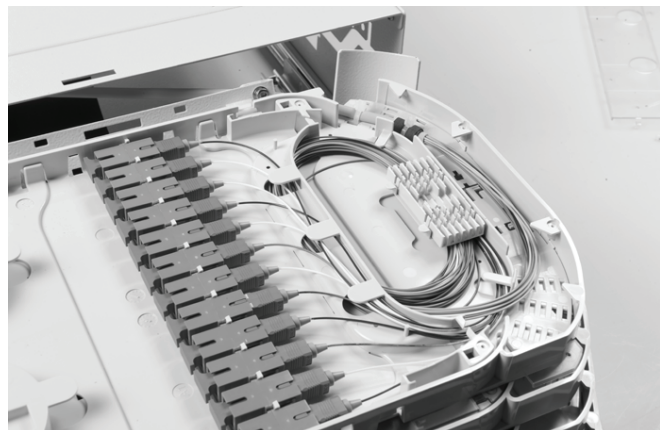

6.3.2 Plug the connectors into the appropriate connector adapters. Coil the IFC overlength into the slack fiber storage area. Fibers must be untangled before coiling.

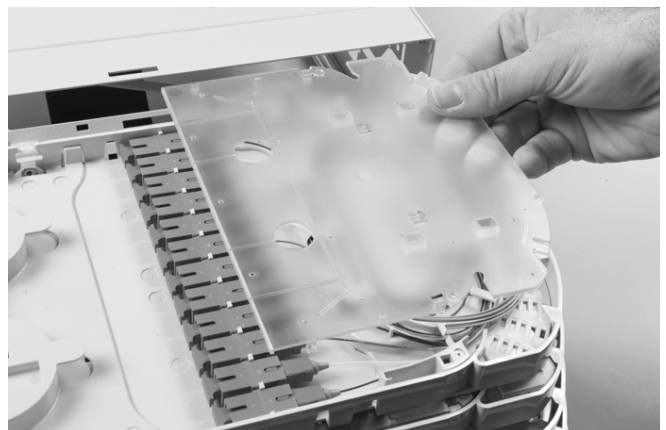

6.3.3 Check whether all fibers are properly routed before placing the cover on the IFC module. All fibers should be underneath the containment lips.

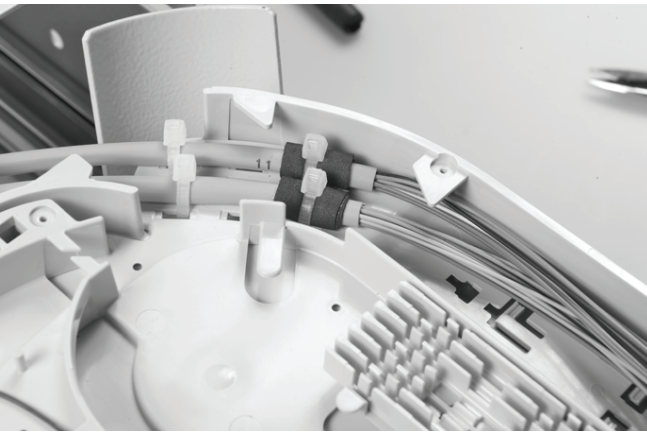

6.3.4 If IFCs are added at a later date, use the other positions to fix it.

7 Patching

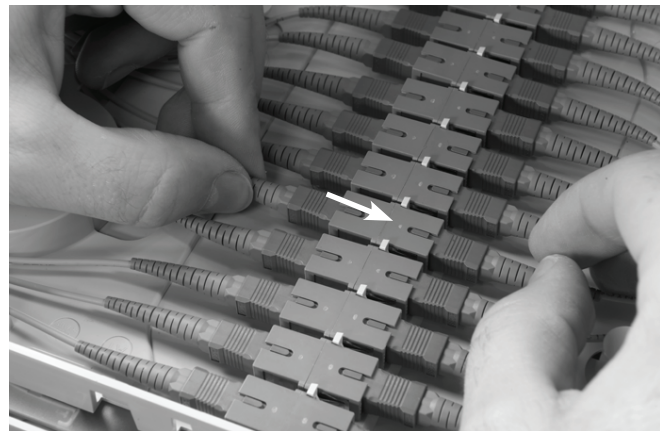
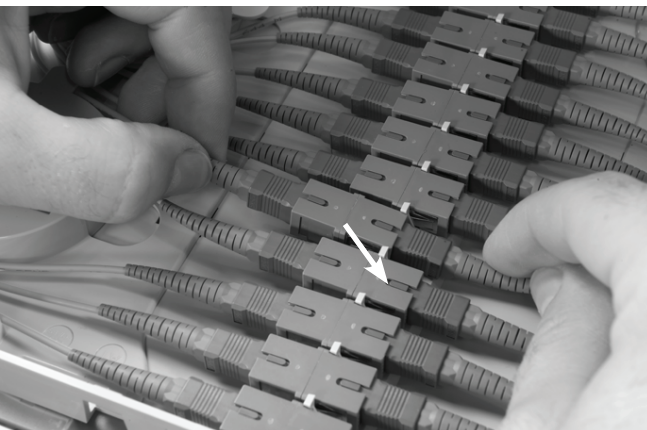
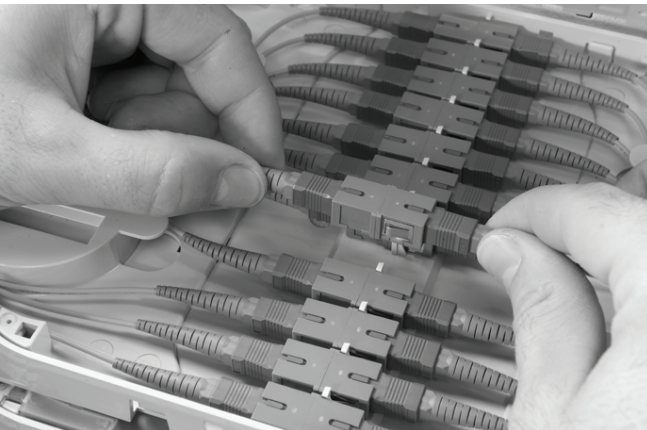
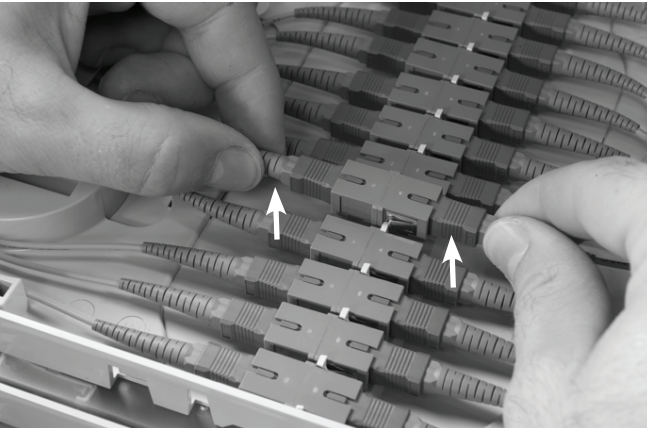

7.1 Route the jumper through the horn up to the tray. Remove the connector adapter out of the tray and mount the connector into it as described.

- To remove adapter from a tray, you need to take it on both sides and pull it up carefully.
- Place the adapter + connector back in the tray by sliding it into the holder from the **left** side.

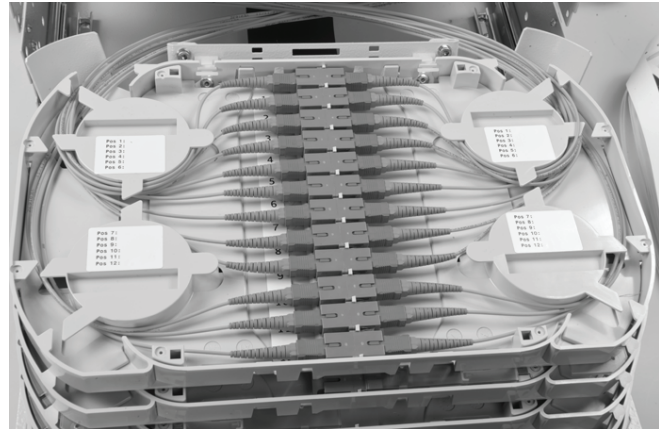

7.2 Repeat this procedure with the other pigtails. Respect jumpers routing as shown on the picture. Provide sufficient slack for patching to all other positions in the shelf.

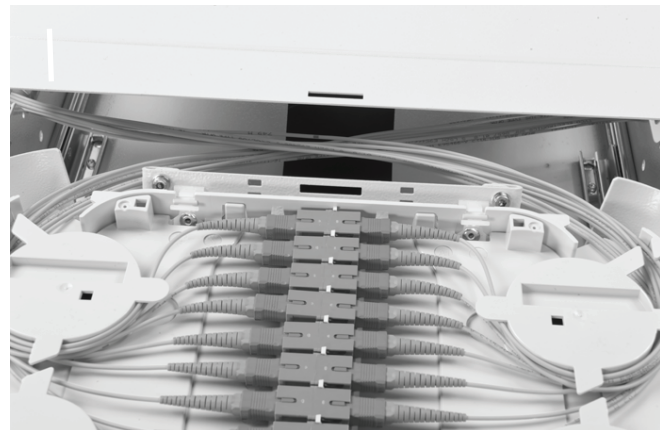

7.3 Routing of incoming pigtails and outgoing patch cords.

8 Closing the shelf

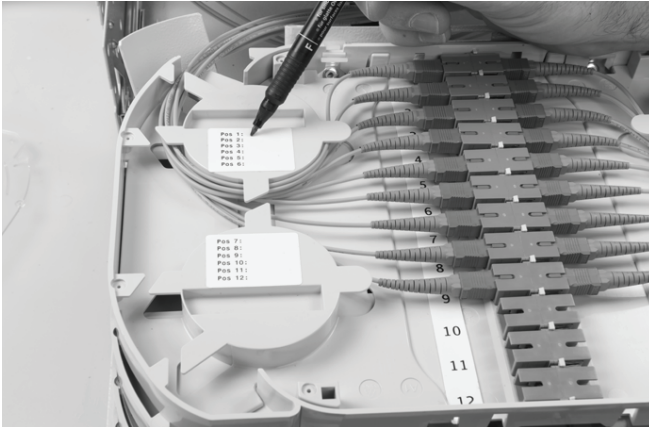

8.1 Place the labels and write down information.

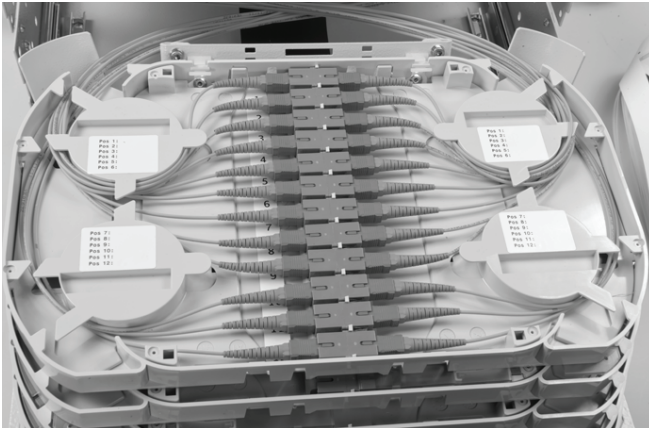

8.2 Picture showing all the available labels for identification.

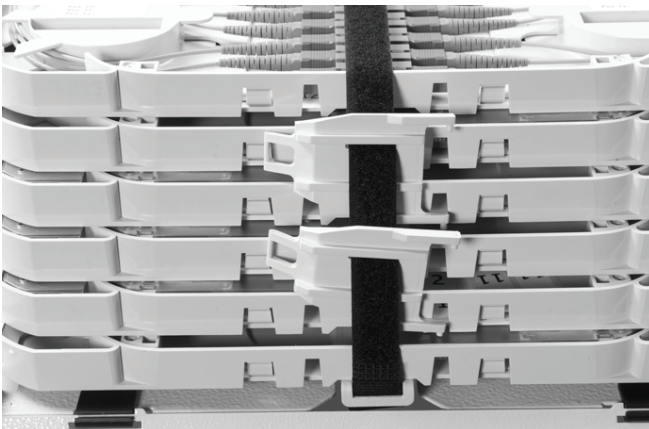

8.3 Place the tray wedges on the fastening strap and secure the trays with the fastening strap. Close the drawer after turning the security clip 180° and by pushing the spring on the right side of the shelf.

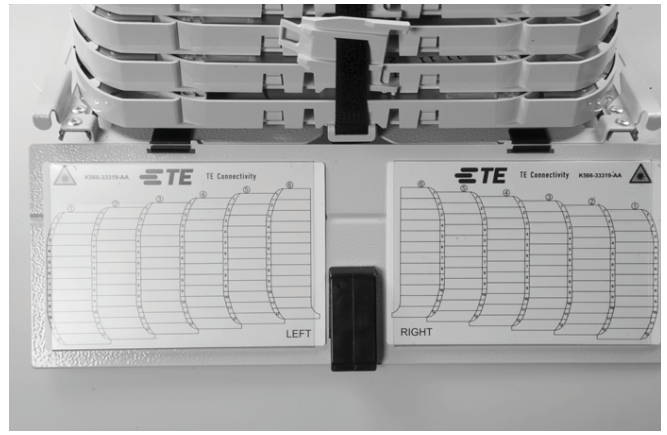

8.4 Shelf contains a label for identification of the shelf and the trays.

9 Important steps

- In case of loose tube termination side or back:
 - don't modify the predefined flex tube length;
 - apply foam tape to the flex tube;
 - apply foam tape to the loose tubes.
- Make sure the transition primary-to-secondary fiber is in a straight line:
 - Under the splice holder (in case of tight coated pigtail: in the splice protector).
- Cut excess length of tie wrap.
- Make sure all fibers and pigtails are properly routed and are under the containment lips.
- Bundle pigtails/patch cords with fastening strap - don't use tie wraps.

To find out more about CommScope® products, visit us on the web at www.commscope.com

For technical assistance, customer service, or to report any missing/damaged parts, visit us at:
<http://www.commscope.com/SupportCenter>

© 2017 CommScope, Inc. All rights reserved.

FIST and all trademarks identified by ® or ™ are registered trademarks or trademarks, respectively, of CommScope, Inc.

This document is for planning purposes only and is not intended to modify or supplement any specifications or warranties relating to CommScope products or services.

This product is covered by one or more U.S. patents or their foreign equivalents. For patents, see:
www.commscope.com/ProductPatent/ProductPatent.aspx.