

TC-1242-IP
 Rev A, Apr 2017
 www.commscope.com

Building distributor

1. Introduction

Suitable for FTTH applications where easily pre-connectorized splitters modules can be built-in. The box is designed to accommodate both spliced and connectorized riser cable solutions, while maximizing the box's capacity.

2 Kit content

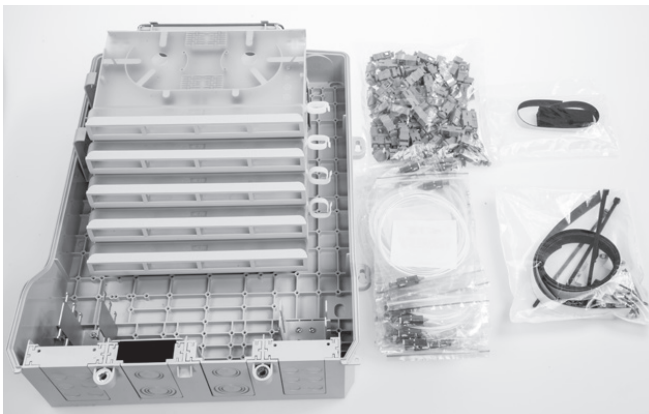

Box

- SC/APC adapters (100 pieces)
- = SC/APC 2 m pigtails (96 pieces)
- Foam (1 mm)
- Hook and loop fastener (6 pieces)

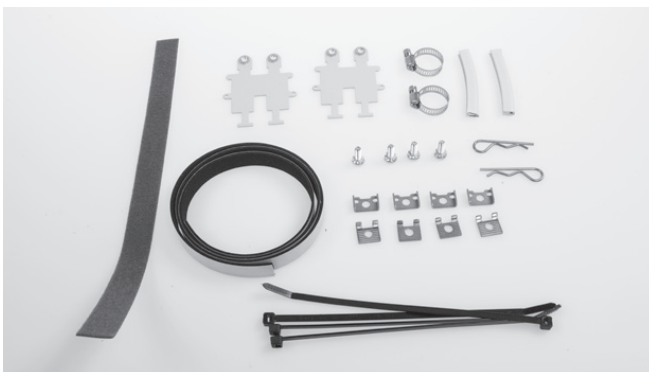

Looped cable accessories
 Seals

Seals

Wrap-around cable seals

Sealblock 6 x 10 mm

Cable diameter (mm)	Foam (± 5 mm)
3	95
4	90
5	80
6	75
7	70
8	60
9	50
10	40

Sealblock 6 x 15 mm

Cable diameter (mm)	Foam (± 5 mm)
9	125
10	115
11	105
12	95
13	85
14	70
15	60

Sealblock 3 x 20 mm

Cable diameter (mm)	Foam (± 5 mm)
14	155
15	140
16	125
17	110
18	95
19	85
20	75

Sealblock 24 x 7 mm

Cable range	A	1.8 – 5 mm
	B	5 – 7 mm

Inline seal 1 x 18

To use in ports S6-S7 only
 Cable range 3 – 18 mm

Standard gland

- PG 16
- PG 21
- PG 29
- PG 29 (PTS 24)

3 Installation of feeder cable

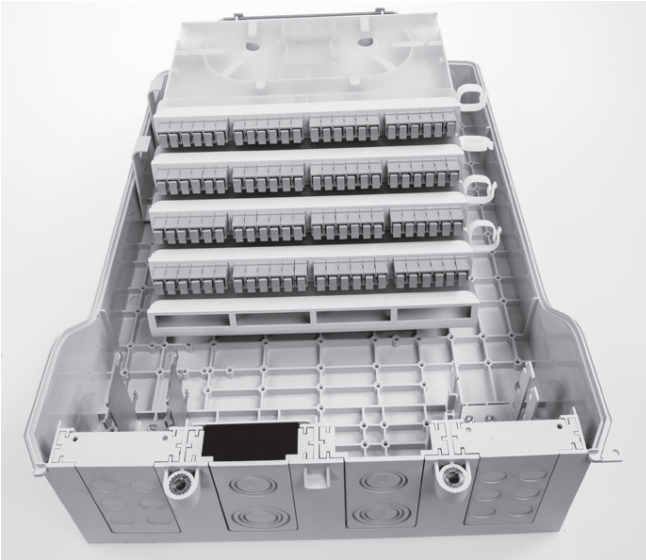

3.1 Install adapters into top 4 trays. The bottom tray is used for the loose tube to be spliced to the splitter inputs.

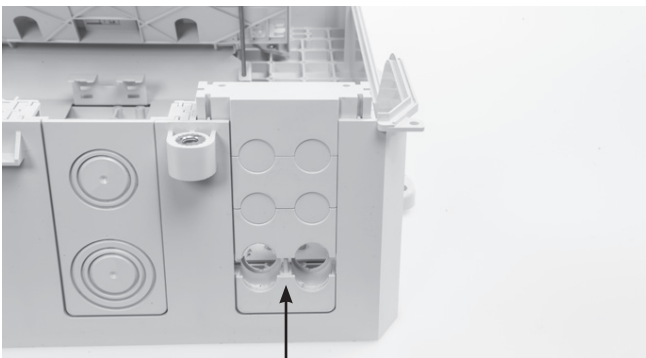
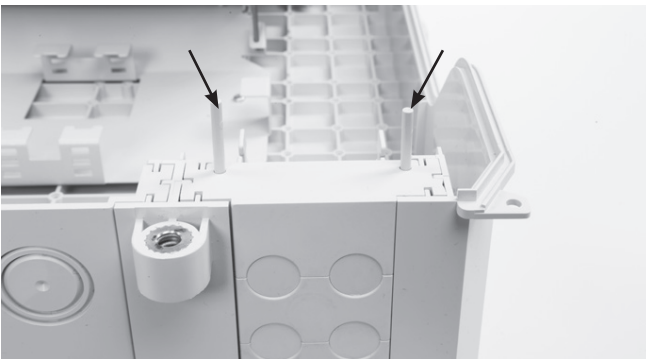

3.2 Use the two guiding pins found on the inside of the box cover to open the ports. Cut out the plastic.

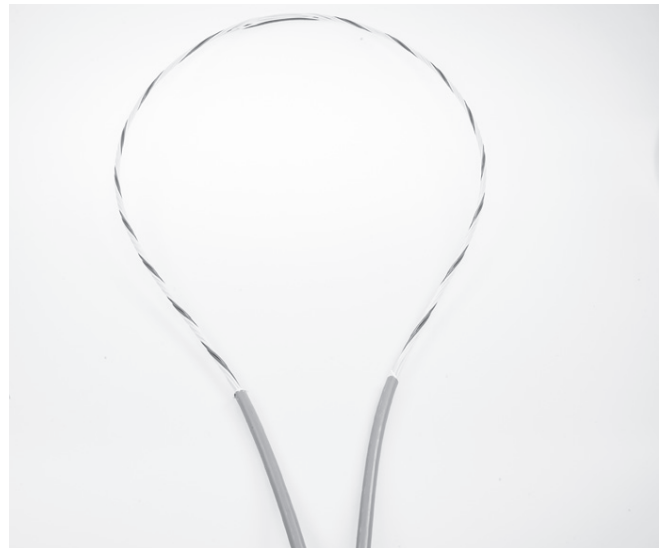

3.3 Make a window cut of 2.7 m.

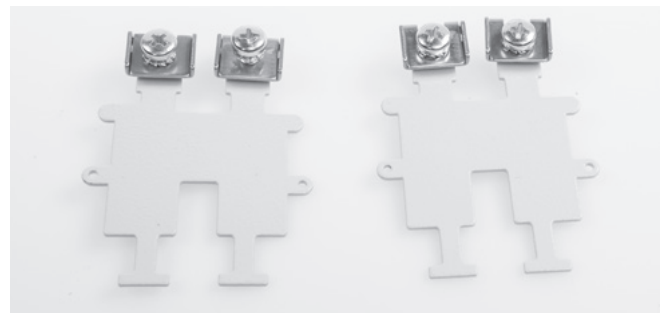

3.4 Prepare the two cable brackets as shown.

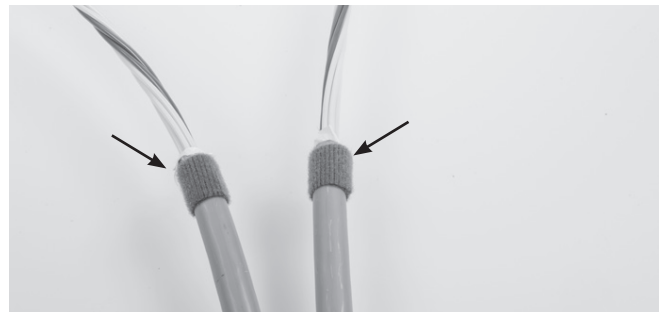

3.5 Apply the hook and loop fastener.

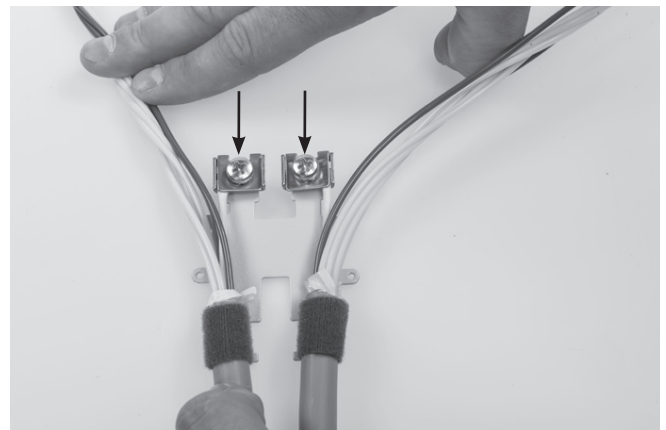

3.6 Cut strength members to the length of 5.5 cm and secure them under the two metal plates.

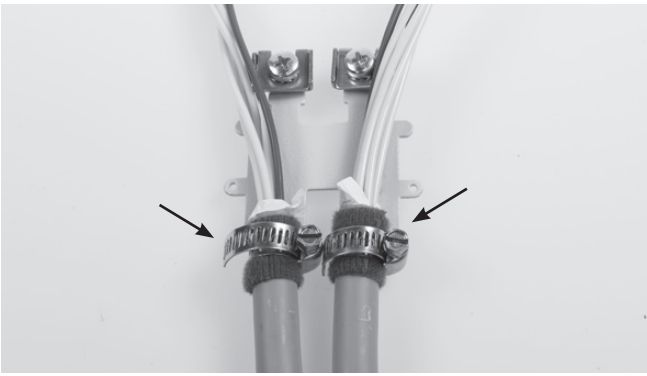

3.7 Secure the looped cable with the two hose clamps.

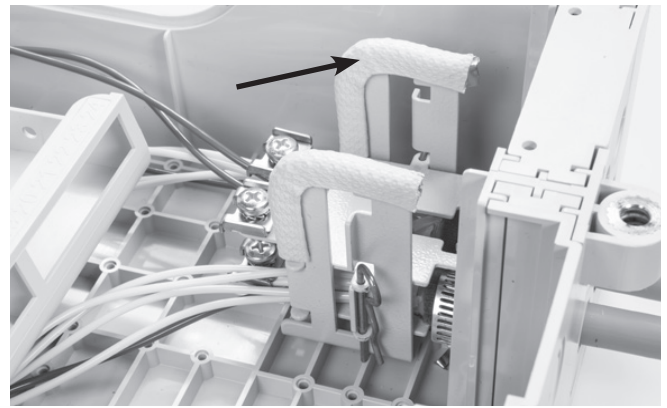

3.11 Install the edge protection.

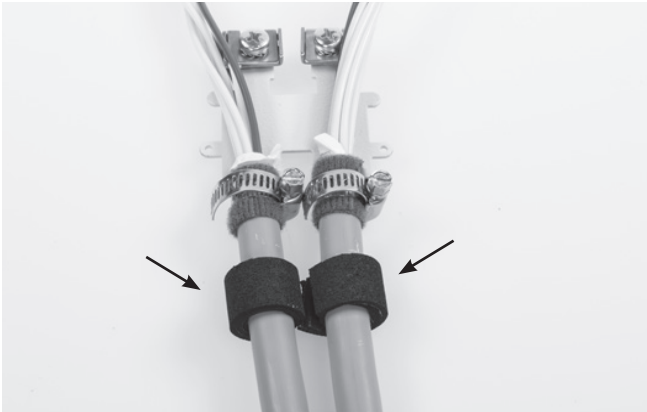

3.8 Apply the foam around the looped cable.



3.12 Take out one loose tube.

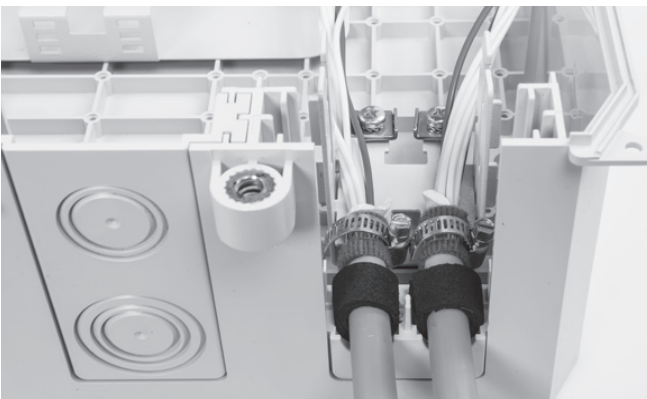

3.9 Install the looped cable into the ports and close the seal.

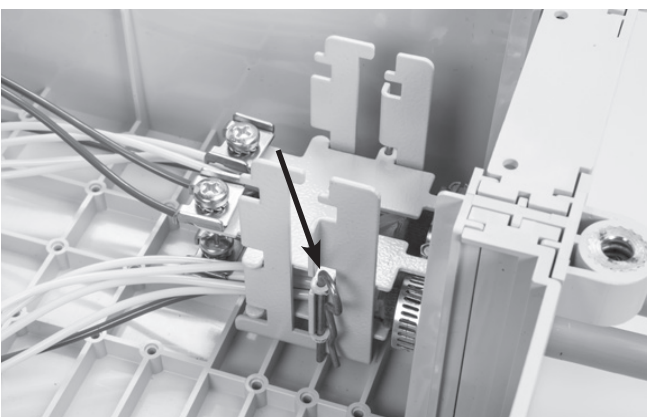

3.10 Install the second cable bracket and secure together with two pins (slide through holes).



3.13 Use a wedge to support the trays. Store the loop on the looped bracket below the trays and secure the loop with two tie-wraps.

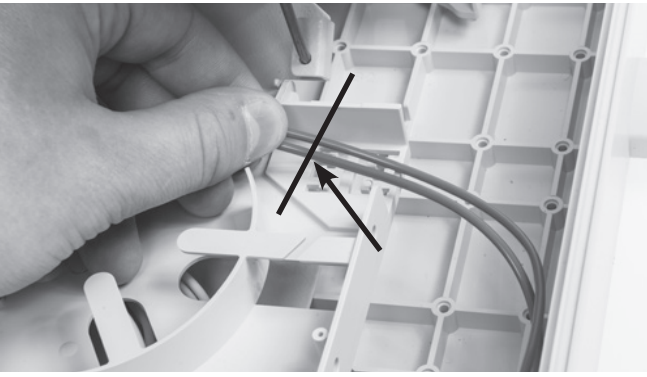

3.14 Mark the loose tube at marked position and shave the tube (**make sure that the unshaved part of the tube is long enough to be able lift the tray**).

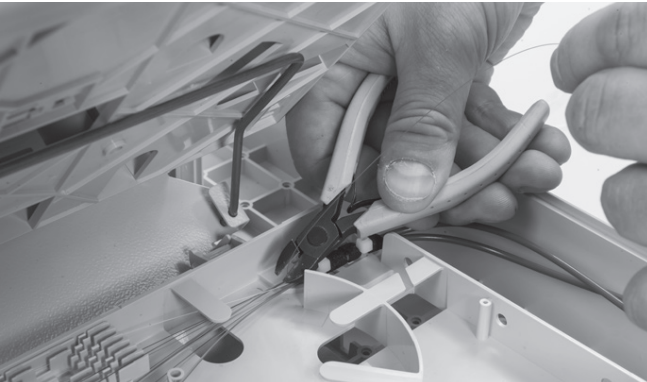

3.15 Apply the foam and secure the loose tubes together with the two tie wraps. Select the fibers to be spliced to the inputs of the OCM6 splitters and cut them off (**do not cut the feeder side**).

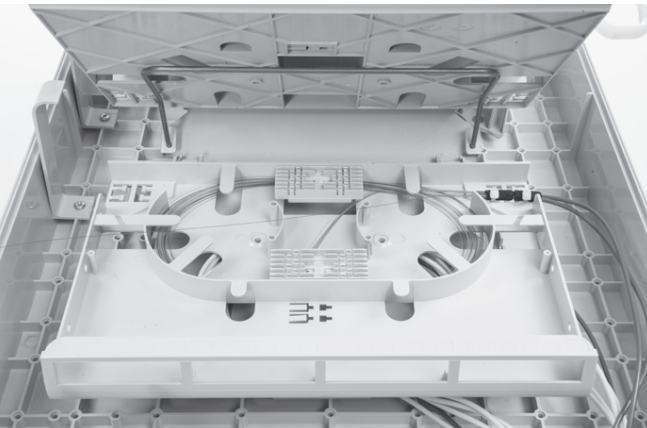

3.16 Store the unused fibers into the tray as shown.

4 Installation of OCM6 splitter

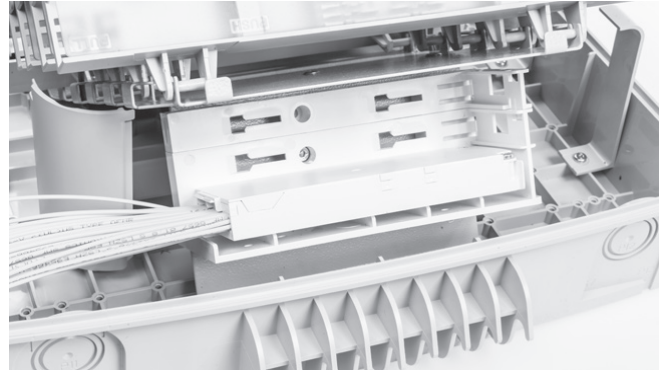
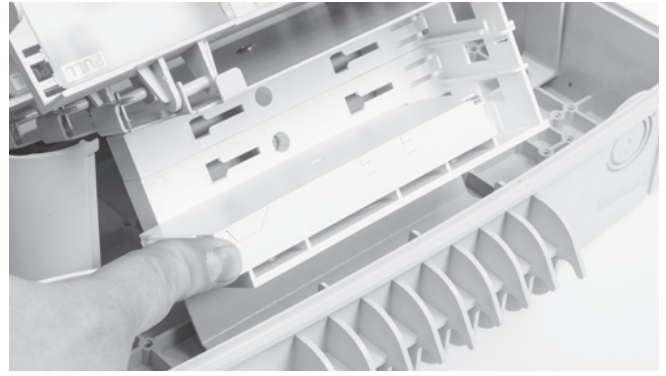

4.1 Install the OCM6 splitter. Up to the three OCM6 splitters can be installed.

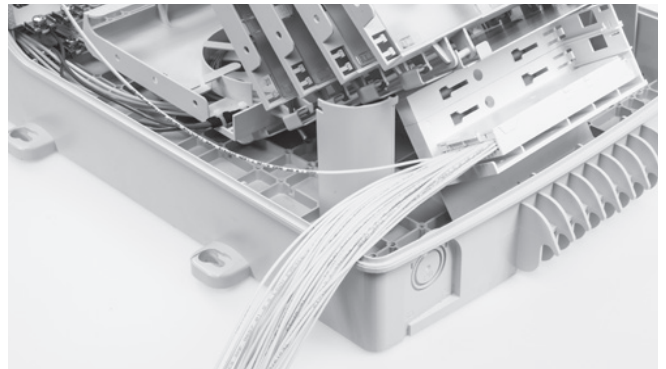

4.2 Guide the input of the OCM6 splitter under the base plate towards to the bottom tray.

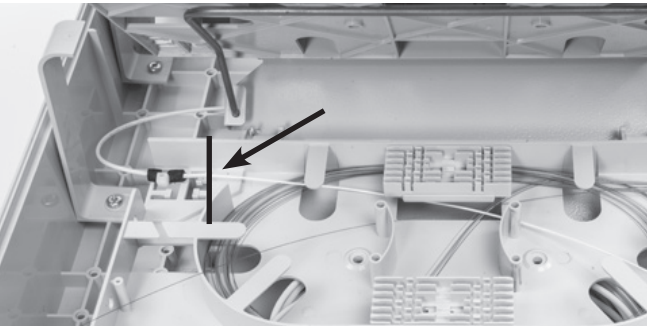

4.3 Strip the OCM6 splitter input at the marked position, apply the foam and secure with the tie wrap. Splice the fibers and store the overlength into the tray.

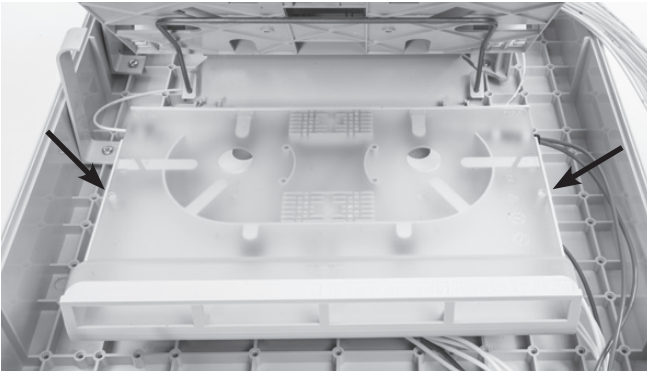

4.4 Install the cover and secure with the two screws.



4.5 Guide the outputs of the OCM6 splitters through the wire saddle.

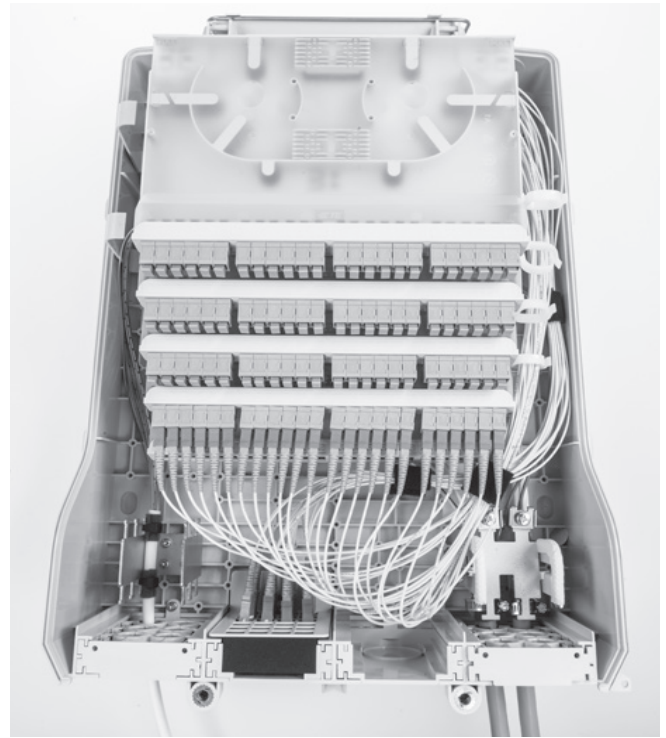
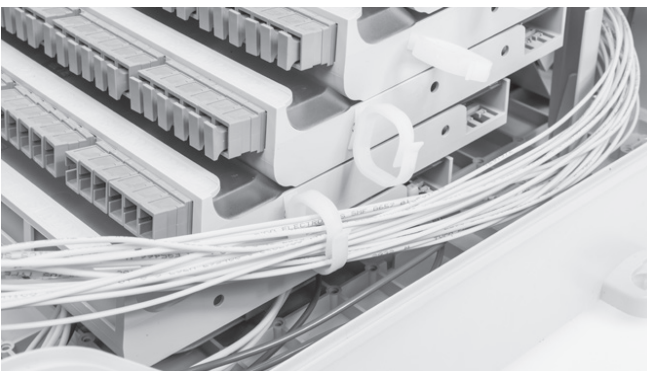

4.6 Connect the outputs of the OCM6 splitter to the designated adapters.

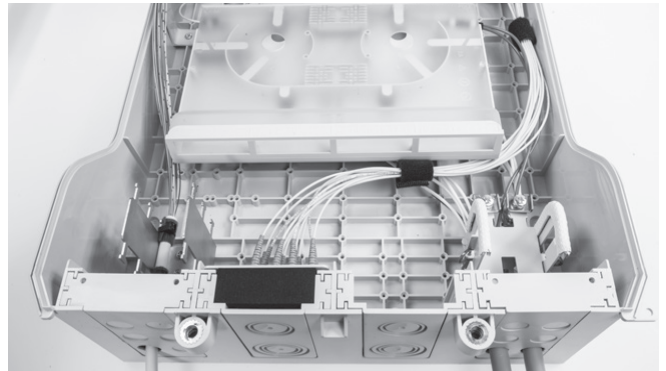

4.7 The unused outputs of the OCM6 splitter can be parked at the bottom of the box in the parking lots. Use the hook and loop fastener for better fiber arrangement.

5 Installation of riser cable

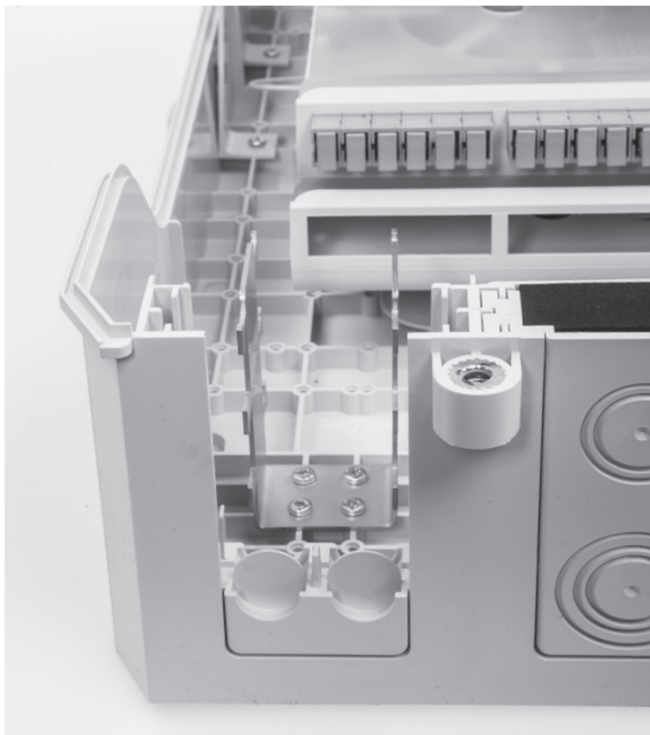

5.1 Prepare the seal port.

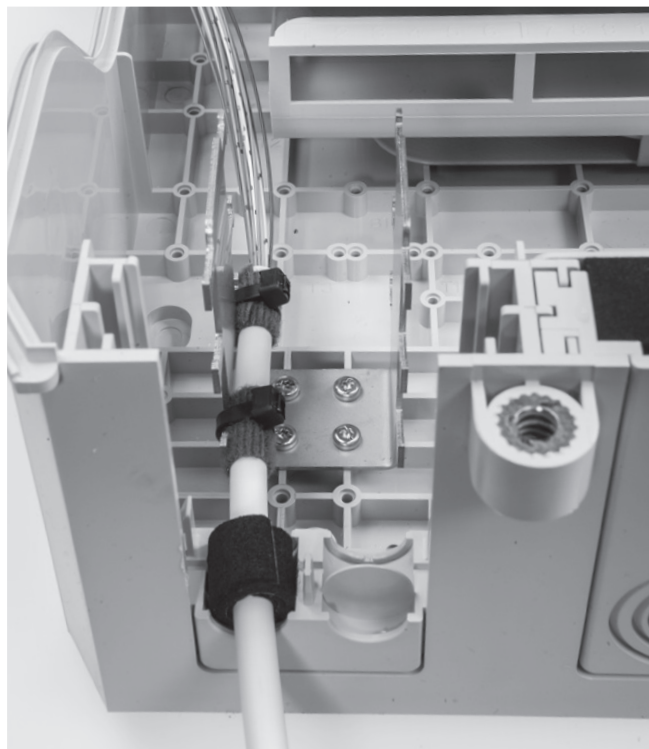

5.3 Install the riser cable into the box on the metal bracket and secure with the two tie-wraps.



5.2 Prepare the riser cable to be installed into the box.

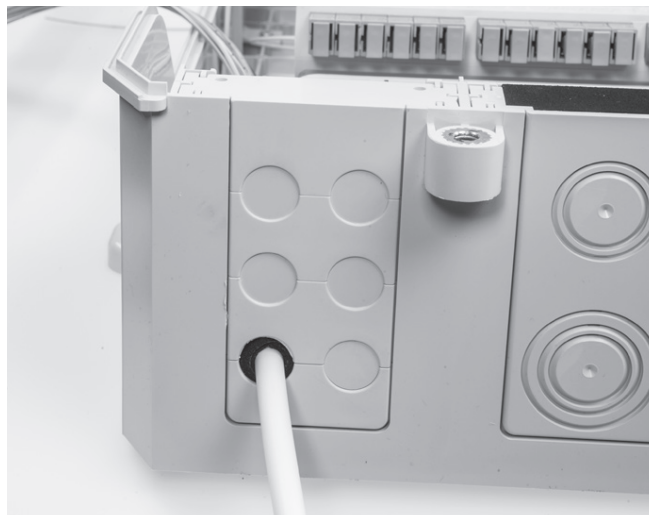

5.4 Close the seal.

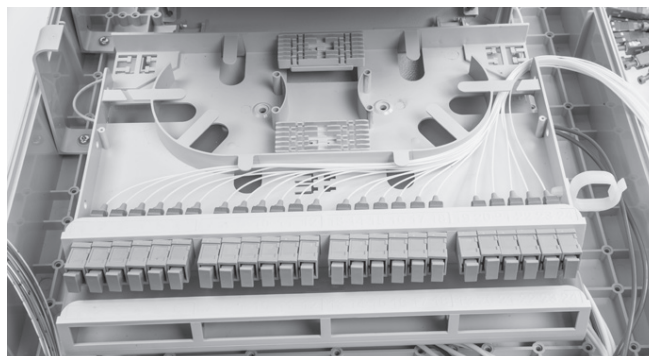

5.5 Install the 900 µm pigtails into the tray.



5.6 Secure the riser cable fibers into the tray with the foam and two tie-wraps.

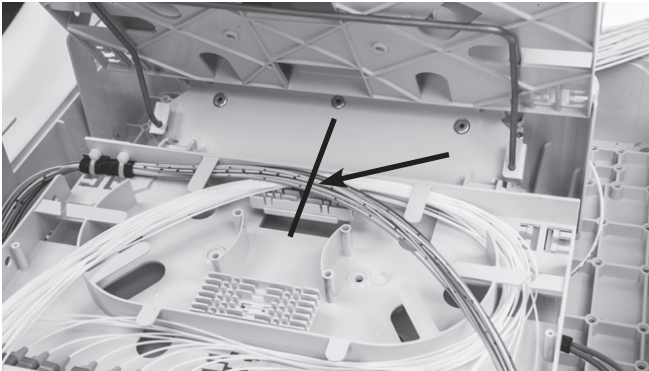

5.7 Strip the pigtails at the marked position.



5.9 Install the cover onto the tray and secure with the two screws.

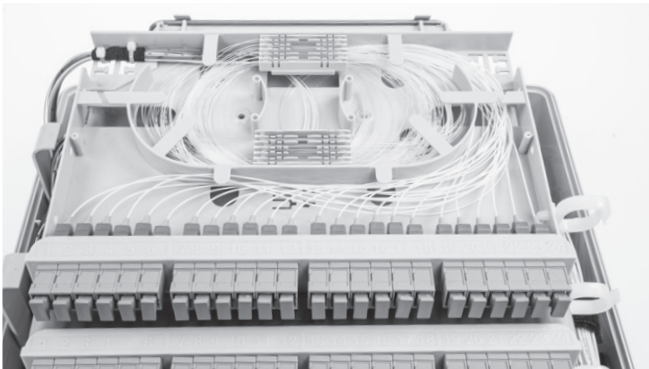

5.8 Splice all the fibers and store the overlength into the tray.

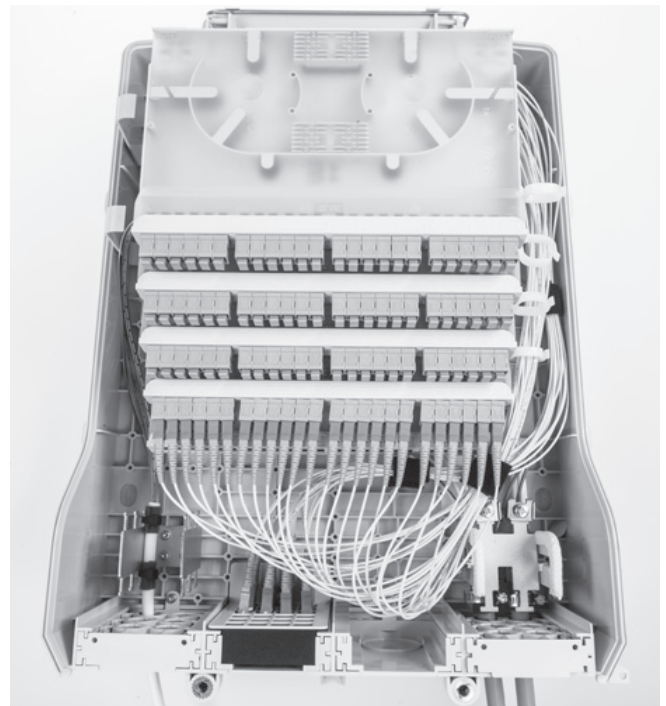

5.9 Install the cover onto the tray and secure with the two screws.

To find out more about CommScope® products, visit us on the web at www.commscope.com

For technical assistance, customer service, or to report any missing/damaged parts, visit us at:
<http://www.commscope.com/SupportCenter>

© 2017 CommScope, Inc. All rights reserved.

All trademarks identified by ® or ™ are registered trademarks or trademarks, respectively, of CommScope, Inc.

This document is for planning purposes only and is not intended to modify or supplement any specifications or warranties relating to CommScope products or services.

This product is covered by one or more U.S. patents or their foreign equivalents. For patents, see:
www.commscope.com/ProductPatent/ProductPatent.aspx.